

# POOL & SPA



Ball Valves - Single Union, Molded in place, 3-way .....	15-18
Butterfly Valves, Accessories, Installation Kits .....	23-27
Check Valves .....	21-22
Clear Braided PVC Hose .....	29-30
Installation & Repair Accessories and Fittings .....	35-37
Pool Floats .....	1
Pressure Gauges .....	7-10
Pressure Gauges - Liquid Filled .....	11-12
Pumps, Utility, Cover .....	50
Rope .....	3
Rope & Float Kits .....	2
Rope Anchors, Hooks & Accessories .....	4
Service Tools & Accessories .....	38-45
Slice Gate Valves .....	19-20
Specialty Pool & Spa Fittings .....	6
Test Kits & Specialty Gauges .....	13
Tubing .....	31-32
Tubing Fittings .....	33-34
Unions .....	5
Wingmaster Pool Service Tools .....	38-45
Winterizing Plugs .....	47-48
Winterizing Products .....	49





IF Series



HF Series



RBF Series

## HARVARD Handi-Lock® Float Features:

- Made of polyethylene and treated with chlorine inhibitors and ultraviolet stabilizers for durability and long life.
- Self locking feature fixes on line without additional expense of float keepers or wedges.
- Three sealed compartments for optimum buoyancy in case of puncture.
- Three inside diameters to accommodate 3/8", 1/2" or 3/4" rope (either hollow braid or twisted).
- Patented. Made in the USA



## HARVARD High Impact Styrene Float Features:

- Blue and white high impact styrene.
- Fits 3/8" hollow braid rope.



## HARVARD Rainbow Style Float Features:

- Polyethylene
- Unsinkable
- Durable
- Chlorine inhibitors and ultraviolet stabilizers added.
- 3" x 5" for 1/2" pool rope and 5" x 9" for 3/4" pool rope available.



Part Number	Float Size	Rope Size	Color	Ctn Qty
IF3538	3" x 5"	3/8"	Blue/White/Blue	50
IF3538R	3" x 5"	3/8"	Red/White/Red	50
IF3538O	3" x 5"	3/8"	Orange/White/Orange	50
IF3550	3" x 5"	1/2"	Blue/White/Blue	50
IF3550R	3" x 5"	1/2"	Red/White/Red	50
IF3550O	3" x 5"	1/2"	Orange/White/ Orange	50
IF3550RWB	3" x 5"	1/2"	Red/White/Blue	50
IF3550 ALL BLUE	3" x 5"	1/2"	Blue/Blue/Blue	50
IF3550 ALL RED	3" x 5"	1/2"	Red/Red/Red	50
IF3550 ALL WHITE	3" x 5"	1/2"	White/White/White	50
IF5950	5" x 9"	1/2"	Blue/White/Blue	24
IF5950R	5" x 9"	1/2"	Red/White/Red	24
IF5950O	5" x 9"	1/2"	Orange/White/Orange	24
IF5950W	5" x 9"	1/2"	White/White/White	24
IF5975	5" x 9"	3/4"	Blue/White/Blue	24
IF5975R	5" x 9"	3/4"	Red/White/Red	24
IF5975O	5" x 9"	3/4"	Orange/ White/Orange	24
IF5975RWB	5" x 9"	3/4"	Red/White/Blue	24
HF35	3" x 5"	3/8"	Blue/White	10
RBF35BW	3" x 5"	1/2"	Blue/White	100
RBF35RW	3" x 5"	1/2"	Red/White	100
RBF35YW	3" x 5"	1/2"	Yellow/White	100
RBF35W	3" x 5"	1/2"	Solid White	100
RBF59BW	5" x 9"	3/4"	Blue/White	24
RBF59RW	5" x 9"	3/4"	Red/White	24
RBF59YW	5" x 9"	3/4"	Yellow/White	24
RBF59WHITE	5" x 9"	3/4"	Solid White	24
RBF59RED	5" x 9"	3/4"	Solid Red	24



IFK Series

### IFK Series Float Kit Features:

- Blue and White Handi-Lock® Floats packaged for 16', 18', 20', 22' and 25' pools.
- Each partially assembled kit contains rope, Handi-Lock® Floats, 2 chrome plated brass rope hooks, splicing FID, and a full set of illustrated instructions.
- Individually packaged in shelf stackable boxes.
- 4 kits per master carton.



RFK Series

### RFK Series Float Kit Features:

- Blue and White styrene float lane markers packaged for 12', 14', 16', 18', 20', 22' and 25' pools.
- Completely assembled and ready to install.
- Each individually bagged kit contains braided polypropylene rope with attractive blue/white floats, prefixed at regular intervals and two chrome plated brass hook eyes.

Part Number	Pool Size	Rope Length	Rope Size	Floats	Ctn Qty
IFK16	16'	18'	3/8"	5	4
IFK18	18'	20'	3/8"	6	4
IFK20	20'	22'	3/8"	7	4
IFK22	22'	24'	3/8"	7	4
IFK25	25'	27'	3/8"	8	4
RFK12	12'	14'	3/8"	5	6
RFK14	14'	16'	3/8"	5	6
RFK16	16'	18'	3/8"	5	6
RFK18	18'	20'	3/8"	7	6
RFK20	20'	22'	3/8"	9	4
RFK22	22'	24'	3/8"	9	4
RFK25	25'	27'	3/8"	10	4
RFK30	30'	28'	3/8"	14	1

Custom Float Kits also available on a special order basis.

# Pool Rope - Twisted/Braided

## Pool Rope Features:

- Polypropylene.
- Floatable.
- Waterproof.
- Rot Resistant.
- Easy to Handle.
- Resists Oil and Gasoline.
- Resists Most Chemicals.
- Resistant to Abrasion.
- Resistant to Color Fading.



PR Series



BPR Series

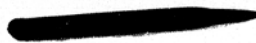

FID

Part Number	Color	Diameter	Length
<b>Twisted Pool Rope</b>			
YR25-500	Solid Yellow	1/4"	500'
PR25-6	Blue/White	1/4"	600'
YR25-1	Solid Yellow	1/4"	1000'
PR38-3R	Red/White	3/8"	300'
PR38-3W	Solid White	3/8"	300'
PR38-4	Blue/White	3/8"	400'
PR38-6	Blue/White	3/8"	600'
PR38-6R	Red/White	3/8"	600'
PR38-6O	Orange/White	3/8"	600'
PR38-6W	Solid White	3/8"	600'
PR38-6Y	Solid Yellow	3/8"	600'
PR50-3	Blue/White	1/2"	300'
PR50-3R	Red/White	1/2"	300'
PR50-3O	Orange/White	1/2"	300'
PR50-6	Blue/White	1/2"	600'
PR50-6R	Red/White	1/2"	600'
PR50-6O	Orange/White	1/2"	600'
PR50-6W	Solid White	1/2"	600'
PR50-6Y	Solid Yellow	1/2"	600'
PR58-6	Blue/White	5/8"	600'
PR75-3	Blue/White	3/4"	300'
PR75-3R	Red/White	3/4"	300'
PR75-3O	Orange/White	3/4"	300'
PR75-3W	Solid White	3/4"	300'
PR75-6	Blue/White	3/4"	600'
PR75-6R	Red/White	3/4"	600'
PR75-6O	Orange/White	3/4"	600'
PR75-6W	Solid White	3/4"	600'
PR75-6Y	Solid Yellow	3/4"	600'
PR75-1	Blue/White	3/4"	1000'
<b>Braided Pool Rope</b>			
BPR38-5	Blue/White	3/8"	500'
<b>Splicing Fid</b>			
FID	Splicing Fid, For 3/8" braided rope		

# Pool Rope Anchors & Hooks

## Chrome Plated Brass Rope Accessory Features:

- Bright chrome finished brass rope accessories.
- Precision cast from corrosion resistant brass.
- Stainless steel fasteners.
- Black or White EPDM gaskets.
- Fully assembled.



HOE2

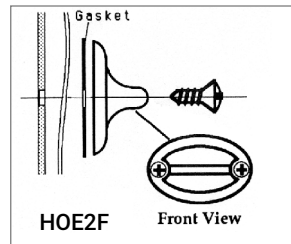
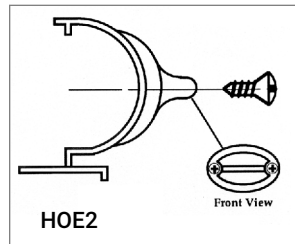

HCA

HEBA



HPRS



HRH



AGHP

Part Number	Description	Ctn Qty
HOE2	Chrome Plated Brass CURVED COPING MOUNT Oval Rope Anchor (Set of 2 w/ ss self tap screws)	72
HOE2F	Chrome Plated Brass FLAT WALL MOUNT Oval Rope Anchor (Set of 2 w/ ss self tap screws, EPDM gasket)	6/72
HCA	Chrome Plated Brass Cup Anchor for concrete pools.	12/120
HEBA	Chrome Plated Brass wall mount eye with washer gasket and nut for vinyl liners. 1-3/8" long bolt	20/200
HPRS	Chrome Plated Strap Type Rope Anchor used under coping for vinyl pools. 14" long	12/252
HRH	Chrome Plated Brass "S" Rope Hook for 1/4"-1/2" rope	500
AGHP52	CLEAT Style Chrome Plated Brass Hook for 3/8" & 1/2" rope w/ ss screws	125
AGHP53	CLEAT Style Chrome Plated Brass Hook for 3/4" rope w/ ss screws	125



### PVC Sch 80 Union Features:

- Ideal for swimming pool, spa and plumbing installations.
- EPDM O-Ring seal.
- Working pressure: 150 PSI at 72°F, 100 PSI at 120°F.
- Meets ASTM standards for Schedule 80 construction.
- Manufactured for AGI in an ISO 9002 facility.
- NSF listed.
- Available white or gray.
- **Third party certified NSF/ANSI 61&372.**

**ISO 9002**

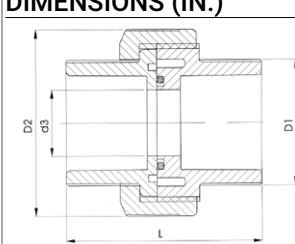
DIMENSIONS (IN.)	SIZE	d3	D1	D2	L
	1/2"	.51	1.21	1.80	2.11
	3/4"	.71	1.45	2.15	2.42
	1"	.92	1.76	2.58	2.69
	1 1/4"	1.17	2.11	3.20	3.32
	1 1/2"	1.52	2.54	3.83	3.40
	2"	1.92	3.05	4.68	3.71
	3"	2.84	3.52	6.10	4.96
	4"	3.94	4.52	8.86	6.30

MATERIAL SPECIFICATIONS	
Body	PVC
End Connector	PVC
Union Nut	PVC
O-Ring	EPDM

Part Number	IPS Size	Ctn Qty
<b>SCHEDULE 80 - WHITE</b>		
<b>SLIP X SLIP</b>	<b>FIPT X FIPT</b>	<b>SLIP X FIPT</b>
PV797-1/2	PV798-1/2	1/2"
PV797-3/4	PV798-3/4	3/4"
PV797-1	PV798-1	1"
PV797-11/4	PV798-11/4	1 1/4"
PV797-11/2	PV798-11/2	PV799-11/2
PV797-2	PV798-2	2"

### SCHEDULE 80 - GRAY

slip x slip	FIPT x FIPT		
PV697-1/2	PV698-1/2	1/2"	36/288
PV697-3/4	PV698-3/4	3/4"	24/144
PV697-1	PV698-1	1"	12/96
PV697-11/4	PV698-11/4	1 1/4"	12/96
PV697-11/2	PV698-11/2	1 1/2"	8/64
PV697-2	PV698-2	2"	4/48
PV697-3	PV698-3	3"	2/12
PV697-4		4"	1/4

### Replacement O-Ring for PV797, PV798, PV799, PV697, PV698

PV796-1/2	1/2"	1
PV796-3/4	3/4"	1
PV796-1	1"	1
PV796-11/4	1 1/4"	1
PV796-11/2	1 1/2"	1
PV796-2	2"	1

### Union Repair Split Nut

SNR150	1 1/2" FBT Repair Split Nut w/ Screw	125
SNR200	2" FBT REpair Split Nut w/ Screw	100





SPA1512

### Pool/Spa Hose Adapter Features:

- Larger hex nut than most other styles
- Ribbed insert end to promote a tight seal and tapered thread to prevent "bottoming out" during installation
- White ABS plastic

Part Number	Description	Ctn Qty
SPA1512	1 1/2" mip x 1 1/2", 1 1/4" combo hose adapter	100

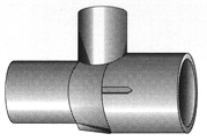

473-210



B1241

Part Number	Description	Ctn Qty
<b>Venturi Tee</b>		
473-825	3/4" x 1" x 3/4" Venturi Tee	50
473-210	1 1/2" x 1 1/2" x 3/4" Venturi Tee	25

### Fittings

B1241-00	1 1/2" 90 elbow, spigot x spigot	25
----------	----------------------------------	----



SW406 Series



SW409 Series

### PVC Sweep Elbow Features:

- Exceeds requirements of CA Title 24, Pool Systems & Equipment Installs.
- Sweep Elbows reduce head loss.
- Socket dimensions to Sch 40 ASTM D 2464.
- Listed to NSF/ANSI Standard 50 Swimming Pools, Spas and Hot Tubs - Circulation System Component.

Part Number	Description	Ctn Qty
SW406-015	1 1/2" PVC Sweep Elbow SL x SL	25
SW406-020	2" PVC Sweep Elbow SL x SL	25
SW406-025	2 1/2" PVC Sweep Elbow SL x SL	25
SW409-015	1 1/2" PVC Sweep Elbow SL x SPG	25
SW409-020	2" PVC Sweep Elbow SL x SPG	25





IPPG or IPG Series

**ISO 9001**

## Pressure Gauge Features:

- Rugged precision made phosphor-bronze Bourdon tube movements assuring maximum accuracy (+/- 3-2-3%) under adverse field conditions.
- **TO BE USED WITH AIR OR WATER ONLY.**
- Manufactured for AGI in an ISO 9001 facility.
- Bourdon tube movement is totally enclosed in corrosion resistant housing.
- Resists rust, electrolytic action and chemical solvents.
- **Third party certified to NSF/ANSI 61&372.** No Lead brass sockets.
- Deep drawn one piece steel or molded plastic housings encase a quality movement.
- Genuine mar-resistant glass or acrylic lens.



**CAUTION**

Part Number	Case	Range	Type	Dial Size	MIP Conn.	Ctn Qty
<b>2" DIAL SIZE, PLASTIC CASE, DRY</b>						
IPPG302-4LNL	Plastic	0-30#	Pressure	2"	1/4 Lower	100
IPPG302-4BNL	Plastic	0-30#	Pressure	2"	1/4 Back	100
IPPG602-4LNL	Plastic	0-60#	Pressure	2"	1/4 Lower	100
IPPG602-4BNL	Plastic	0-60#	Pressure	2"	1/4 Back	100
IPPG1002-4LNL	Plastic	0-100#	Pressure	2"	1/4 Lower	100
EIPPG1002-4LPNL	Plastic	0-100#	Pressure	2" No dial logo	1/4 Lower	100
IPPG1002-4BNL	Plastic	0-100#	Pressure	2"	1/4 Back	100
IPVG302-4LNL	Plastic	0-30 Hg"	Vacuum	2"	1/4 Lower	100
<b>2" DIAL SIZE, STEEL CASE, DRY</b>						
IPG152-4LNL	Steel	0-15#	Pressure	2"	1/4 Lower	100
IPG302-4LNL	Steel	0-30#	Pressure	2"	1/4 Lower	100
IPG302-4BNL	Steel	0-30#	Pressure	2"	1/4 Back	100
IPG302-8LNL	Steel	0-30#	Pressure	2"	1/8 Lower	100
IPG302-8BNL	Steel	0-30#	Pressure	2"	1/8 Back	100
IPG602-4LNL	Steel	0-60#	Pressure	2"	1/4 Lower	100
IPG602-4BNL	Steel	0-60#	Pressure	2"	1/4 Back	100
IPG602-8LNL	Steel	0-60#	Pressure	2"	1/8 Lower	100
IPG1002-4LNL	Steel	0-100#	Pressure	2"	1/4 Lower	100
EIPG1002-4LPNL	Steel	0-100#	Pressure	2" No dial logo	1/4 Lower	100
IPG1002-4BNL	Steel	0-100#	Pressure	2"	1/4 Back	100
IPG1002-8LNL	Steel	0-100#	Pressure	2"	1/8 Lower	100
IPG1002-8BNL	Steel	0-100#	Pressure	2"	1/8 Back	100
IPG1602-4LNL	Steel	0-160#	Pressure	2"	1/4 Lower	100

# Pressure Gauges - NO LEAD Dry

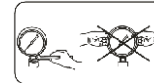

**CAUTION**



Part Number	Case	Range	Type	Dial Size	MIP Conn.	Ctn Qty
<b>2" DIAL SIZE, STEEL CASE, DRY</b>						
IPG2002-4LNL	Steel	0-200#	Pressure	2"	1/4 Lower	100
IPG2002-4BNL	Steel	0-200#	Pressure	2"	1/4 Back	100
IPG2002-8LNL	Steel	0-200#	Pressure	2"	1/8 Lower	100
IPG3002-4LNL	Steel	0-300#	Pressure	2"	1/4 Lower	100
IPVG302-4BNL	Steel	0-30 Hg"	Vacuum	2"	1/4 Back	100
IPVG302-8LNL	Steel	0-30 Hg"	Vacuum	2"	1/8 Lower	100
IPCG3102-4LNL	Steel	30 Hg"/160#	Vacuum/Pressure	2"	1/4 Lower	100
IPCG3602-4LNL	Steel	30Hg"/60#	Vacuum/PResure	2"	1/4 Lower	200
<b>2" DIAL SIZE, STAINLESS STEEL CASE, 316SS INTERNALS and MOUNT, DRY</b>						
EIPG1002-4LSS316	Stainless Steel	0-100#	Pressure	2"	1/4 Lower	100
EIPG1002-4BSS316	Stainless Steel	0-100#	Pressure	2"	1/4 Back	100
EIPG2002-4LSS316	Stainless Steel	0-200#	Pressure	2"	1/4 Lower	100
EIPG2002-4BSS316	Stainless Steel	0-200#	Pressure	2"	1/4 Back	100
<b>2 1/2" DIAL SIZE, DRY</b>						
IPG1525-4LNL	Plastic	0-15#	Pressure	2 1/2"	1/4 Lower	100
IPG3025-4LNL	Steel	0-30#	Pressure	2 1/2"	1/4 Lower	100
IPG6025-4LNL	Steel	0-60#	Pressure	2 1/2"	1/4 Lower	100
IPG10025-4LNL	Steel	0-100#	Pressure	2 1/2"	1/4 Lower	50
IPG16025-4LNL	Steel	0-160#	Pressure	2 1/2"	1/4 Lower	100
IPG20025-4LNL	Steel	0-200#	Pressure	2 1/2"	1/4 Lower	100
IPG30025-4LNL	Steel	0-300#	Pressure	2 1/2"	1/4 Lower	50
IPG40025-4LNL	Steel	0-400#	Pressure	2 1/2"	1/4 Lower	50
IPVG3025-4LNL	Plastic	0-30 Hg"	Vacuum	2 1/2"	1/4 Lower	50
IPCG31025-4LNL	Steel	30 Hg"/160#	Vacuum/Pressure	2 1/2"	1/4 Lower	50
<b>3 1/2" DIAL SIZE, STEEL CASE, DRY</b>						
IPG3035-4LNL	Steel	0-30#	Pressure	3 1/2"	1/4 Lower	50
IPG10035-4LNL	Steel	0-100#	Pressure	3 1/2"	1/4 Lower	50
IPG20035-4LNL	Steel	0-200#	Pressure	3 1/2"	1/4 Lower	50
IPG30035-4LNL	Steel	0-300#	Pressure	3 1/2"	1/4 Lower	50
<b>4 1/2" DIAL SIZE, STEEL CASE, DRY</b>						
IPG3045-4LNL	Steel	0-30#	Pressure	4 1/2"	1/4 Lower	50
IPG6045-4LNL	Steel	0-60#	Pressure	4 1/2"	1/4 Lower	50
IPG10045-4LNL	Steel	0-100#	Pressure	4 1/2"	1/4 Lower	50
IPG20045-4LNL	Steel	0-200#	Pressure	4 1/2"	1/4 Lower	50
IPG30045-4LNL	Steel	0-300#	Pressure	4 1/2"	1/4 Lower	50
IPVG3045-4LNL	Steel	30 Hg"	Vacuum	4 1/2"	1/4 Lower	50
IPCG36045-4LNL	Steel	30 Hg"/60#	Vacuum/Pressure	4 1/2"	1/4 Lower	50
IPCG31045-4LNL	Steel	30 Hg"/160#	Vacuum/Pressure	4 1/2"	1/4 Lower	50



Pressure Gauge

ISO 9001

### Pressure Gauge Features:

- Rugged precision made phosphor-bronze Bourdon tube movements assuring maximum accuracy (+/- 3-2-3%) under adverse field conditions.
- **TO BE USED WITH AIR OR WATER ONLY.**
- Manufactured for AGI in an ISO 9001 facility.

### POLYPROPYLENE CASE:

- Bourdon tube movement is totally enclosed in corrosion resistant polypropylene housing, acrylic lens.
- Resists rust, electrolytic action and chemical solvents.
- Brass sockets standard.

### STEEL CASE:

- Deep drawn one piece steel housing encases a quality movement.
- Genuine mar-resistant glass lens and brass socket connections are standard.



CAUTION

Part Number	Case	Range	Type	Dial Size	MIP Conn.	Ctn Qty
<b>2" DIAL SIZE, PLASTIC CASE, DRY</b>						
IPPG302-4L	Plastic	0-30#	Pressure	2"	1/4 Lower	100
IPPG302-4B	Plastic	0-30#	Pressure	2"	1/4 Back	100
IPPG602-4L	Plastic	0-60#	Pressure	2"	1/4 Lower	100
IPPG602-4B	Plastic	0-60#	Pressure	2"	1/4 Back	100
IPPG1002-4L	Plastic	0-100#	Pressure	2"	1/4 Lower	100
IPVG302-4L	Plastic	0-30 Hg"	Vacuum	2"	1/4 Lower	100
<b>2" DIAL SIZE, STEEL CASE, DRY</b>						
IPG302-4L	Steel	0-30#	Pressure	2"	1/4 Lower	100
IPG302-4B	Steel	0-30#	Pressure	2"	1/4 Back	100
IPG302-8L	Steel	0-30#	Pressure	2"	1/8 Lower	100
IPG302-8B	Steel	0-30#	Pressure	2"	1/8 Back	100
IPG602-4L	Steel	0-60#	Pressure	2"	1/4 Lower	100
IPG602-4B	Steel	0-60#	Pressure	2"	1/4 Back	100
IPG602-8L	Steel	0-60#	Pressure	2"	1/8 Lower	100
IPG1002-4L	Steel	0-100#	Pressure	2"	1/4 Lower	100
IPG1002-8B	Steel	0-100#	Pressure	2"	1/8 Back	100

# Pressure Gauges - Dry

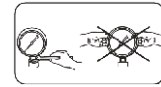

CAUTION



Part Number	Case	Range	Type	Dial Size	MIP Conn.	Ctn Qty
<b>2" DIAL SIZE, STEEL CASE, DRY</b>						
IPVG302-4B	Steel	0-30 Hg"	Vacuum	2"	1/4 Back	100
IPVG302-8L	Steel	0-30 Hg"	Vacuum	2"	1/8 Lower	100
IPCG3602-4L	Steel	30Hg"/60#	Vacuum/PResure	2"	1/4 Lower	200
<b>2 1/2" DIAL SIZE, DRY</b>						
IPG3025-4L	Steel	0-30#	Pressure	2 1/2"	1/4 Lower	100
IPG6025-4L	Steel	0-60#	Pressure	2 1/2"	1/4 Lower	100
IPG10025-4L	Steel	0-100#	Pressure	2 1/2"	1/4 Lower	50
IPG16025-4L	Steel	0-160#	Pressure	2 1/2"	1/4 Lower	100
IPVG3025-4L	Plastic	0-30 Hg"	Vacuum	2 1/2"	1/4 Lower	50
<b>4 1/2" DIAL SIZE, STEEL CASE, DRY</b>						
IPG3045-4L	Steel	0-30#	Pressure	4 1/2"	1/4 Lower	50
IPG6045-4L	Steel	0-60#	Pressure	4 1/2"	1/4 Lower	50
IPG10045-4L	Steel	0-100#	Pressure	4 1/2"	1/4 Lower	50
IPVG3045-4L	Steel	30 Hg"	Vacuum	4 1/2"	1/4 Lower	50
IPCG36045-4L	Steel	30 Hg"/60#	Vacuum/Pressure	4 1/2"	1/4 Lower	50
IPCG31045-4L	Steel	30 Hg"/160#	Vacuum/Pressure	4 1/2"	1/4 Lower	50

# Pressure Gauges - NO LEAD Liquid Filled



EILPG Series



ILPG Series

## Liquid Filled Pressure Gauge Features:

- Stainless steel or black steel case.
- Glycerine filled, phosphor bronze bourdon tube.
- Accuracy +/- 3-2-3%.
- 2" or 2 1/2" Dial face with clear acrylic lens.
- Crimped stainless steel ring.
- For use in high vibration, corrosion situations.
- **Third party certified to NSF/ANSI 61&372.**
- No lead brass or stainless steel sockets.
- **TO BE USED WITH AIR OR WATER ONLY.**



**CAUTION**

Part Number	Case	Range	Type	Dial Size	MIP Conn.	Ctn Qty
<b>2" DIAL SIZE, LIQUID FILLED</b>						
EILPG302-4LNL	Steel	0-30#	Pressure	2"	1/4" Lower	100
EILPG602-4LNL	Steel	0-60#	Pressure	2"	1/4" Lower	100
EILPG602-4BNL	Steel	0-60#	Pressure	2"	1/4" Back	100
EILPG1002-4LNL	Steel	0-100#	Pressure	2"	1/4" Lower	100
EILPG1002-4BNL	Steel	0-100#	Pressure	2"	1/4" Back	100
EILPG1002-8BNL	Steel	0-100#	Pressure	2"	1/8" Back	100
EILPG1602-4LNL	Steel	0-160#	Pressure	2"	1/4" Lower	100
EILPG2002-4LNL	Steel	0-200#	Pressure	2"	1/4" Lower	100
EILVG302-4LNL	Steel	0-30 Hg"	Vacuum	2"	1/4" Lower	100
EILVG302-4BNL	Steel	0-30 Hg"	Vacuum	2"	1/4" Back	100
EILPG302-4LSSNL	Stainless Steel	0-30#	Pressure	2"	1/4" Lower	100
EILPG602-4LSSNL	Stainless Steel	0-60#	Pressure	2"	1/4" Lower	100
EILPG602-4BSSNL	Stainless Steel	0-60#	Pressure	2"	1/4" Back	100
EILPG1002-4LSSNL	Stainless Steel	0-100#	Pressure	2"	1/4" Lower	100
EILPG1002-4LSS316*	Stainless Steel 316	0-100#	Pressure	2"	1/4" Lower	100
EILPG1002-4BSSNL	Stainless Steel	0-100#	Pressure	2"	1/4" Back	100
EILPG1002-4BSS316*	Stainless Steel 316	0-100#	Pressure	2"	1/4" Back	100
EILPG1602-4LSSNL	Stainless Steel	0-160#	Pressure	2"	1/4" Lower	100
EILPG2002-4LSSNL	Stainless Steel	0-200#	Pressure	2"	1/4" Lower	100
EILVG302-4LSSNL	Stainless Steel	0-30 Hg"	Vacuum	2"	1/4" Lower	100
EILVG302-4BSSNL	Stainless Steel	0-30 Hg"	Vacuum	2"	1/4" Back	100
* 316 Stainless steel internals and mount.						
<b>2 1/2" DIAL SIZE, LIQUID FILLED</b>						
ILPG3025-4LNL	Stainless Steel	0-30#	Pressure	2 1/2"	1/4 Lower	50
ILPG6025-4LNL	Stainless Steel	0-60#	Pressure	2 1/2"	1/4 Lower	50
ILPG10025-4LNL	Stainless Steel	0-100#	Pressure	2 1/2"	1/4 Lower	50
ILPG16025-4LNL	Stainless Steel	0-160#	Pressure	2 1/2"	1/4 Lower	50
ILPG20025-4LNL	Stainless Steel	0-200#	Pressure	2 1/2"	1/4 Lower	50
ILPG30025-4LNL	Stainless Steel	0-300#	Pressure	2 1/2"	1/4 Lower	50
ILPG40025-4LNL	Stainless Steel	0-400#	Pressure	2 1/2"	1/4 Lower	50
ILVG3025-4LNL	Stainless Steel	0-30 Hg"	Vacuum	2 1/2"	1/4 Lower	50
ILVG3025-4BNL	Stainless Steel	0-30 Hg"	Vacuum	2 1/2"	1/4 Back	50
ILCG36025-4LNL	Stainless Steel	30 Hg"/60#	Vacuum/Press	2 1/2"	1/4 Lower	50

# Pressure Gauges - Liquid Filled



EILPG Series



ILPG Series

## Liquid Filled Pressure Gauge Features:

- Stainless steel or black steel case
- Glycerine Filled, Phosphor bronze bourdon tube
- Accuracy +/- 3-2-3%
- 2" or 2 1/2" Dial face with clear acrylic lens
- Crimped stainless steel ring
- For use in high vibration, corrosion situations
- **TO BE USED WITH AIR OR WATER ONLY.**



**CAUTION**

Part Number	Case	Range	Type	Dial Size	MIP Conn.	Ctn Qty
<b>2" DIAL SIZE, LIQUID FILLED</b>						
EILPG302-4L	Steel	0-30#	Pressure	2"	1/4" Lower	100
EILPG602-4L	Steel	0-60#	Pressure	2"	1/4" Lower	100
EILPG602-4B	Steel	0-60#	Pressure	2"	1/4" Back	100
EILPG1002-4L	Steel	0-100#	Pressure	2"	1/4" Lower	100
EILPG1002-4B	Steel	0-100#	Pressure	2"	1/4" Back	100
EILPG1602-4L	Steel	0-160#	Pressure	2"	1/4" Lower	100
EILVG302-4L	Steel	0-30 Hg"	Vacuum	2"	1/4" Lower	100
EILPG302-4LSS	Stainless Steel	0-30#	Pressure	2"	1/4" Lower	100
EILPG602-4LSS	Stainless Steel	0-60#	Pressure	2"	1/4" Lower	100
EILPG602-4BSS	Stainless Steel	0-60#	Pressure	2"	1/4" Back	100
EILPG1002-4LSS	Stainless Steel	0-100#	Pressure	2"	1/4" Lower	100
EILVG302-4LSS	Stainless Steel	0-30 Hg"	Vacuum	2"	1/4" Lower	100
<b>2 1/2" DIAL SIZE, LIQUID FILLED</b>						
ILPG3025-4L	Stainless Steel	0-30#	Pressure	2 1/2"	1/4 Lower	50
ILPG6025-4L	Stainless Steel	0-60#	Pressure	2 1/2"	1/4 Lower	50
ILPG10025-4L	Stainless Steel	0-100#	Pressure	2 1/2"	1/4 Lower	50
ILPG16025-4L	Stainless Steel	0-160#	Pressure	2 1/2"	1/4 Lower	50
ILPG20025-4L	Stainless Steel	0-200#	Pressure	2 1/2"	1/4 Lower	50
ILVG3025-4L	Stainless Steel	0-30 Hg"	Vacuum	2 1/2"	1/4 Lower	50
ILCG36025-4L	Stainless Steel	30 Hg"/60#	Vacuum/Press	2 1/2"	1/4 Lower	50



### Pool Test Kit Features:

- For pressure testing pool systems
- Unassembled kits individually boxed
- Includes PVC Sch 40 Reducing Tee, PVC Sch 40 Reducing Bushing, Brass Boiler Drain, 3/4", 60# 2" plastic case pressure gauge, 1/4" lower brass mount.

Part Number	Description	Ctn Qty
TK150	1 1/2" Pool Test Kit	8
TK200	2" Pool Test Kit	8



### Pressure Air Test Gauge Features:

- Quick, easy means of pressurizing and monitoring plumbing systems for leakage.
- Attach to hose bibb.
- Includes brass hex manifold, air valve, 2" 200# gauge, garden hose thread fitting.

Part Number	Description	Ctn Qty
PATG200	Pressure Air Test Gauge	30



PGBS



### Pressure Gauge Brass Snubber Features:

- Use with any pressure gauge subjected to rapidly fluctuating pressures or sudden shock pressure.
- Brass housing with high strength sintered, porous type snubbing element.

Part Number	Size/Description	Ctn Qty
PGBS1/4	1/4" mpt x 1/4" fpt Brass Snubber	50/500



PTG1002

### Pressure Test Gauge Features:

- 0-100 psi, 2" plastic lens.
- Brass test fitting with pressure release button.
- Heavy rubber boot to protect gauge from damage.

Part Number	Size	Pressure Setting/Description	Ctn Qty
PTG1002	2" case	0-100# Pressure test gauge	50



WTG

### Water Test Gauge Features:

- Quick, easy method to test a wide range of pressure systems for leakage.
- 2 1/2" dial face, steel case pressure gauge w/ plastic lens.
- With standard 3/4" FGHT swivel garden hose connection with rubber washer.
- Attach to hose bibbs, boiler drains and lawn faucets for pressure testing.
- "MP" series MAX pointer arm measures maximum water surge or pressure drop.
- Individually cartoned.



WTG MP



Part Number	Size	Pressure Setting/Description	PSI dial increments	Ctn Qty
WTG100	2 1/2"	0-100# water test gauge, fght	1	50
WTG200	2 1/2"	0-200# water test gauge, fght	2	50
WTG300	2 1/2"	0-300# water test gauge, fght	3	100
WTG100MP	2 1/2"	0-100# gauge with MAX pointer	1	50
WTG200MP	2 1/2"	0-200# gauge with MAX pointer	2	50
WTG300MP	2 1/2"	0-300# gauge with MAX pointer	3	50



## PVC Single Union Ball Valve Features:



PV1450 Series



PV1452, PV1453 Series

ISO 9002



- PVC Type 1 construction for compatibility in joining rigid PVC and flex vinyl pipes.
- **PTFE seats.**
- **Double EPDM o-ring seal on stem: single EPDM o-ring seal on union end.**
- Fully round ball prevents foreign matter from scoring seats.
- Tee handle for quarter turn on/off with stops.
- Working pressure: 150 PSI at 72°F, 100 PSI at 120°F.
- Threaded or socket.
- Manufactured for AGI in an ISO 9002 facility.
- Imported

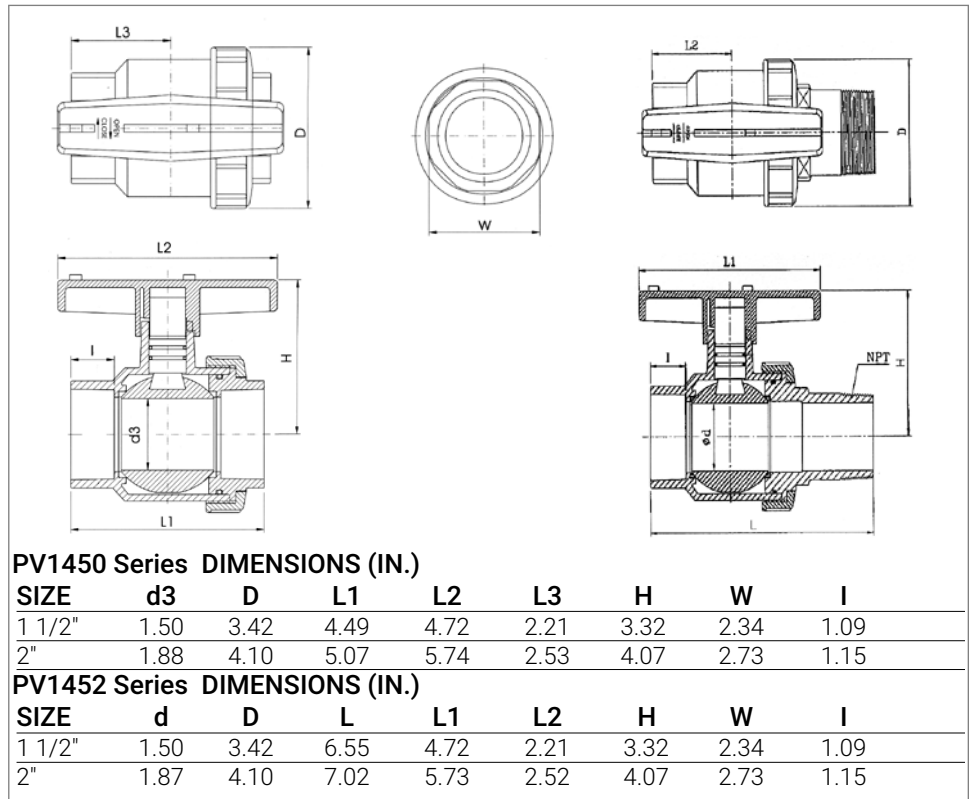

### MATERIAL SPECIFICATIONS

Body	PVC
End Adapter	PVC
Union Nut	PVC
Ball	PVC
Stem	PVC
Handle	ABS
Union o-rings	EPDM
Seat Seals	PTFE
Stem o-rings	EPDM

Part Number	Threaded/Slip	Size	Ctn Qty
PV1450-11/2	Slip	1-1/2"	48
PV1450-2	Slip	2"	24
PV1451-11/2	Threaded	1-1/2"	48
PV1451-2	Threaded	2"	24
PV1452-11/2	Slip x Extended MIP	1 1/2"	24
PV1452-2	Slip x Extended MIP	2"	24
PV1453-11/2	FPT x Extended MIP	1 1/2"	24
PV1453-2	FPT x Extended MIP	2"	12



## Economy Series PVC Molded-In-Place Ball Valve Features:

- Heavy duty thermoplastic white PVC (Type 1, Grade 1) construction.
- White body, blue handle.
- **Straight lever** handle on 1/2" through 2". **Curved lever** handle on 2 1/2", 3" and 4".
- EPDM seats provide excellent chemical resistance.
- EPDM "o" ring stem seal.
- 150 PSI working pressure at 73°F water, non-shock.
- Maintenance free compact design.
- Severe shock loads and misalignment stress are absorbed by the valve body, not the ball & seat, minimizing the chance of uneven wear & leakage.
- Third party certified no lead to NSF/ANSI 61&372.
- Individually cartoned.
- Imported.



CV (GPM/(1 lbf/in <sup>2</sup> ) <sup>1/2</sup> ) Opening Rate: 90"	
SIZE	CV
1/2"	14.5
3/4"	29.5
1"	48.0
1 1/4"	71.0
1 1/2"	135.0
2"	180.0
2 1/2"	225.0
3"	400.0
4"	865.9

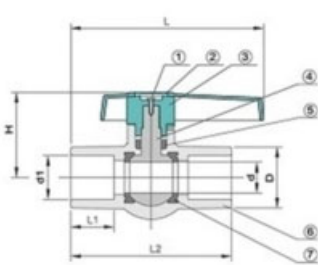

### EMIP TE/SE Series IPS DIMENSIONS (mm)

SIZE	d	d1	D	L1	L	H
1/2"	15	21.54	31.4	19.6	91	34.5
3/4"	20	26.87	36.8	20.4	103	51.0
1"	25	33.65	43.0	26.4	119	58.5
1 1/4"	32	24.42	42.5	27.0	134	67.4
1 1/2"	36	48.56	63.2	30.9	154	73.2
2"	48	60.63	76.4	38.0	180	87.0
2 1/2"	63	73.38	90	45.0	182	103.5
3"	75	89.31	109	50.4	223	118.5
4"	97	114.76	132	62.6	252	130.3

### MATERIAL SPECIFICATIONS

1	Screw	Zinc Plated Steel
2	Cap	ABS
3	Handle	ABS
4	Ball	PVC
5	Stem Seal o-ring	EPDM
6	Body	PVC
7	Seat Seal	EPDM

Threaded Part Number	Slip Part Number	Size	Master Case Qty
EMIP50TE	EMIP50SE	1/2"	210
EMIP75TE	EMIP75SE	3/4"	137
EMIP100TE	EMIP100SE	1"	95
EMIP125TE	EMIP125SE	1 1/4"	56
EMIP150TE	EMIP150SE	1 1/2"	36
EMIP200TE	EMIP200SE	2"	24
EIMP250TE	EMIP250SE	2 1/2"	9
EMIP300TE	EMIP300SE	3"	8
EMIP400TE	EMIP400SE	4"	6

### Relations Between Temperature and Pressure

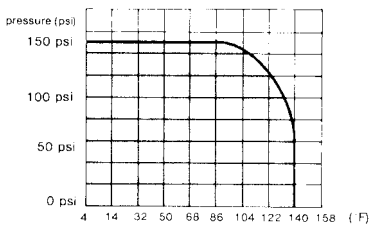



## SCH 80 Series PVC Molded-In-Place Ball Valve Features:

- Heavy duty thermoplastic white PVC (Type 1, Grade 1) construction. Materials meet NSF standards.
- Meets ASTM 2467 Schedule 80.
- White body, red handle.
- Available with PTFE or EPDM seats providing excellent chemical resistance.
- EPDM "o" ring stem seal
- **150 PSI** working pressure at 73°F water, non-shock.
- Maintenance free compact design.
- Severe shock loads and misalignment stress are absorbed by the valve body, not the ball & seat, minimizing the chance of uneven wear & leakage.
- Individually cartoned.
- Manufactured for AGI in an ISO 9002 facility.
- **Third party certified to NSF/ANSI 61&372.**

MATERIAL SPECIFICATIONS	
Body	PVC
Seat Seal	EPDM, PTFE
Ball	PVC
Stem Seal o-ring	EPDM
Handle	ABS
Bolt	Zinc Plated Steel
Cap	ABS



Certified to  
ANSI-NSF 61 &  
ANSI-NSF 61 Annex G



**NO LEAD**  
< 0.25% Pb by  
weighted avg  
Third Party Certified  
to NSF / ANSI 372

**ISO 9002**

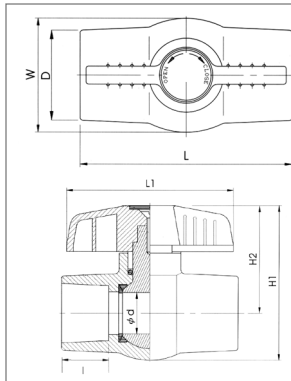

## HMIP TE/SE and T/S Series IPS DIMENSIONS (IN.)

SIZE	d	D	L	L1	I	H1	H2	W
1/2"	.55	1.17	3.24	2.73	.87	2.42	1.68	1.48
3/4"	.78	1.48	3.71	3.43	1.00	3.04	2.11	1.67
1"	.98	1.76	4.13	3.90	1.12	3.63	2.54	2.22
1 1/4"	1.17	2.11	4.45	3.90	1.25	3.82	2.61	2.46
1 1/2"	1.40	2.42	5.07	4.25	1.37	4.49	3.04	2.93
2"	1.82	3.00	5.74	5.23	1.50	5.27	3.47	3.59
2 1/2"	2.34	3.59	7.96	6.94	1.75	6.24	4.10	4.29
3"	3.00	4.13	8.93	8.74	1.88	7.41	4.84	5.19
4"	3.94	5.27	11.70	10.76	2.25	9.09	5.77	6.63

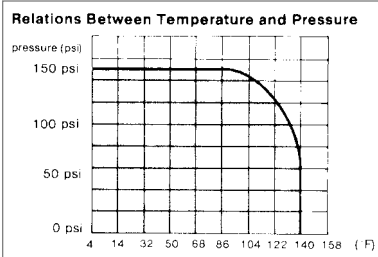

**CV (GPM/(1 lbf/in<sup>2</sup>)<sup>1/2</sup>)  
Opening Rate: 90"**

SIZE	CV
1/2"	8.84
1"	25.24
1 1/4"	38.53
1 1/2"	51.28
2"	96.67
2 1/2"	162.37
3"	438.81
4"	865.90
CMIP-C Series excluded	

## WITH EPDM SEATS

Threaded	Slip	Size	Ctn Qty
Part Number	Part Number		
HMIP50TE	HMIP50SE	1/2"	100
HMIP75TE	HMIP75SE	3/4"	100
HMIP100TE	HMIP100SE	1"	100
HMIP125TE	HMIP125SE	1 1/4"	100
HMIP150TE	HMIP150SE	1 1/2"	48
HMIP200TE	HMIP200SE	2"	24
HIMP250TE	HMIP250SE	2 1/2"	12
HMIP300TE	HMIP300SE	3"	12
HMIP400TE	HMIP400SE	4"	6

## WITH PTFE SEATS

Threaded	Slip	Size	Ctn Qty
Part Number	Part Number		
HMIP50T	HMIP50S	1/2"	100
HMIP75T	HMIP75S	3/4"	100
HMIP100T	HMIP100S	1"	100
HMIP125T	HMIP125S	1 1/4"	100
HMIP150T	HMIP150S	1 1/2"	48
HMIP200T	HMIP200S	2"	24

# Ball Valves - CPVC Sch 80 Molded-in-Place



ISO 9002

**FLOWGUARD GOLD®**  
PIPE & FITTINGS

## SCH 80 Series CPVC Molded-in-Place Ball Valve Features:

- Made with **Flo Guard Gold CPVC** material.
- Heavy duty thermoplastic CPVC construction for hot water use.
- NSF listed.
- Meets ASTM 2467 Schedule 80.
- CTS slip x slip - cream body, orange handle.
- PTFE seats providing excellent chemical resistance.
- EPDM O-Ring stem seal.
- Working pressure 75 PSI at 180°F.
- Maintenance free compact design.
- Severe shock loads & misalignment stress are absorbed by the valve body, not the ball & seat, minimizing the chance of uneven wear & leakage.
- Individually cartoned.
- Manufactured for AGI in an ISO 9002 facility.
- **Third party certified to NSF/ANSI 61&372.**

### MATERIAL SPECIFICATIONS

Body	CPVC
Seat Seal	PTFE
Ball	CPVC
Stem Seal	EPDM
Handle	ABS
Bolt	Zinc Plated Steel
Cap	ABS

### Relations Between Temperature and Pressure

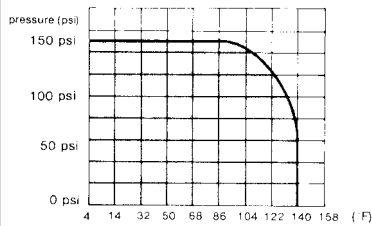

### CV (GPM/(1 lbf/in<sup>2</sup>)<sup>1/2</sup>) Opening Rate: 90"

SIZE	CV
1/2"	14.5
3/4"	29.5
1"	48.0

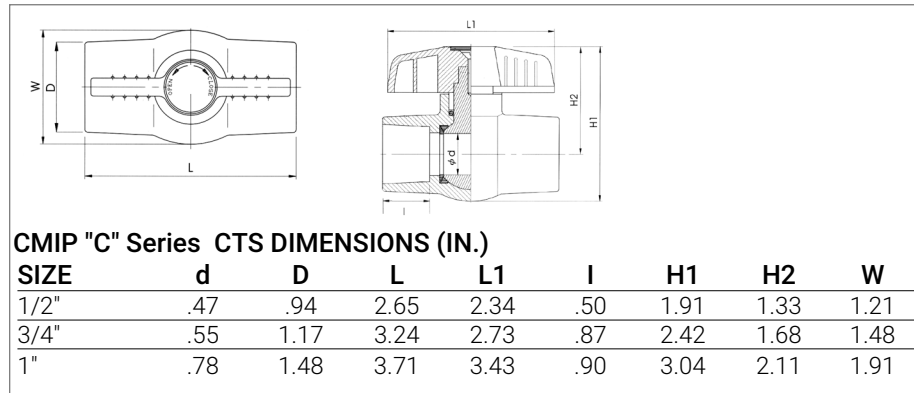

### CMIP "C" Series CTS DIMENSIONS (IN.)

SIZE	d	D	L	L1	I	H1	H2	W
1/2"	.47	.94	2.65	2.34	.50	1.91	1.33	1.21
3/4"	.55	1.17	3.24	2.73	.87	2.42	1.68	1.48
1"	.78	1.48	3.71	3.43	.90	3.04	2.11	1.91

Part Number	Description	Ctn Qty
-------------	-------------	---------

### CPVC Ball Valve, Copper Tube Size, SLIP X SLIP

CMIP50C	1/2" SLIP X SLIP	100
CMIP75C	3/4" slip x slip	100
CMIP100C	1" slip x slip	100



VSGV Uni-Body



VSGV 3 piece body



VSGV 3 piece body  
with union

## PVC Slice Gate Valve Features:

- Designed for pool & spa, irrigation, plumbing, waste water and agricultural applications.
- Stainless steel shaft prevent rust and corrosion.
- Ozone & chemical resistant Santoprene™ materials.
- Santoprene™ seals are integrated to the paddle to eliminate any chance of torn or punctured gaskets.
- Maximum working pressure 50 psi (through 2").
- Solvent cement traps to catch excess glue.
- Every valve tested at double recommended working pressure.
- Valterra's patent pending triple o-ring neck seal to ensure against any chance of shaft leakage.



## Unibody Design

- One piece uni-body design.
- Combination socket ID x spigot OD for installation flexibility.
- Locking handle provides positive shutt-off and easy gate opening.

## 3 Piece body

- Three piece configuration allows for repair or can be used as a union.
- Three piece configuration easily disassembles for inline service.

Part Number	Description	Max PSI	Ctn Qty
<b>Uni-Body</b>			
VSGV2101	1 1/2" slip x slip	45	30
VSGV2201	2" slip x slip	40	20
<b>* Unibody 2" slip hubs are 2" slip or 2 1/2" spigot</b>			
<b>Three Piece Body</b>			
VSGV150SL	1 1/2" slip x slip	45	30
VSGV150FIPTXMIPT	1 1/2" fipt x mipt	45	40
VSGV150SLU	1 1/2" slip x union slip	45	38
VSGV150SD	1 1/2" step down pool hose x mipt ABS	40	
VSGV200SL	2" slip x slip	40	20
VSGV200SP	2" slip x spigot	40	34
VSGV300SL	3" slip x slip	30	15
VSGV400SL	4" slip x slip w/ metal handle	20	6
VSGV600SL	6" slip x slip w/ stainless handle	10	1
VSGV800SL	8" slip x slip w/ stainless handle	10	1
VSGV1000SL	10" slip x slip w/ stainless handle	10	1
VSGV1200SL	12" slip x slip w/ stainless handle	10	1



## PVC Slice Gate Valve

- One piece "Uni-Body" PVC Construction. Guaranteed NO HUB LEAKS or loose bolts.
- 1/4 turn "Cam-Lock" for 100% shut-off..
- Internal "snap-lock" feature ensures valve will remain totally open, providing 100% flow with no restriction.
- Stainless steel shaft prevents rust and corrosion.
- Glass filled poly-pro tapered gate design for 100% sealing.
- Integrally molded seal on gate. - No pinched or torn gaskets.
- Seals are "Santoprene" that have been impregnated with a permanent lubricant. Never needs lube yet will provide continuous smooth operation. Ozone and chemical resistant for much longer life.
- Santoprene buttons on gate provides smooth operation without sticking.
- Every valve water tested at 100PSI and random quick burst tested at 400 PSI. Virtually no chance of leaky valves in the field at standard operating pressures.
- Maximum recommended operating pressure is 50 PSI.
- Glue wells on all slip-socket configuration catches excess glue during plumbing.
- Constructed and tested for use in pool & spa applications.
- Made in USA



SGV - SL Series



SGV-SP and SGV-SLU Series

Part Number	Size	Description	Ctn/Case Qty
SGV150SL	1 1/2"	Slip x Slip	14/56
SGV200SL	2"	Slip x Slip	12/48
SGV250SL	2 1/2"	Slip x Slip	5/20
SGV150SP	1 1/2"	Slip x Spigot	14/56
SGV200SP	2"	Slip x Spigot	12/48
SGV150SLU	1 1/2"	Slip x Slip with Union	10/40
SGV200SLU	2"	Slip x Slip with Union	10/40



MCRV Series

## "CR" Full Flow Corrosion Resistant Check Valve Features:

- Protects heat exchangers from potential damage by inline chlorinators.
- Maintains full flow circulation system.
- Proprietary designed Hastelloy spring.
- Glass filled Noryl injection molded shaft.
- 100% silicone gasket never requires lubrication.
- Clear sight glass. Removable, servicable.
- 3 IPS sizes in one valve. 1 1/2" slip with bushing, 2" slip and 2 1/2" spigot. ( 1 1/2" bushing sold separately.)
- Spring loaded flapper/gate mechanism assures full flow and minimum cavitation.
- Positive water seal when in the closed position.
- "CR" valve can be installed in virtually any position.
- Use in highly corrosive conditions and conditions needing backflow prevention.

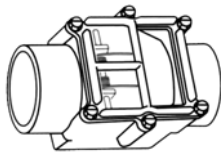

MCRV Series



Bushing

Part Number	Description	Size	Ctn Qty
MCRV801-20H	PVC CR Swing Check Valve	2" Slip x Slip	12
60104028	CR Swing Check Bushing	2" Sp x 1 1/2" Slip	1

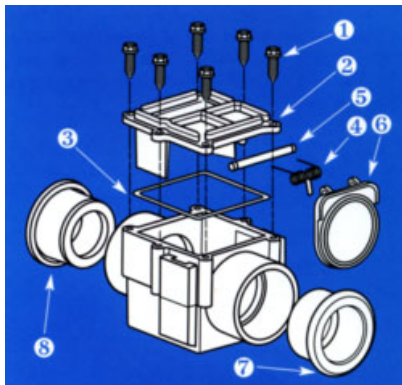

## CR VALVE REPLACEMENT PARTS

ID	Part Number	Description	Ctn Qty
1	M04030066	#14 x 1" Phillips Pan Head SS Screw	6
4	M0405001	Spring	1
5	M0401005P	Shaft	1
6	M0081201020	Gate Assembly	1
7	M0060504028	Adapter 2" sp x 1 1/2" Slip, Black	1
8	M0060104028	Adapter, 2" sp x 1 1/2" Slip, White	1

# Check Valves - PVC Swing



MCV Series



## “Smart” Swing Check Valve Features:

- Patented innovation in swing check valve technology eliminates in-line flow restriction of conventional check valves.
- Spring loaded swing check flapper/gate allows full flow and reliable back flow prevention.
- Standard “smart” check valve remains closed to 1/2 psi, then open for full flow.
- Magnetic “smart” check valves remain closed to 2 psi, then open for full flow.

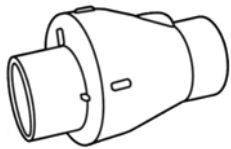

MCV821 Series

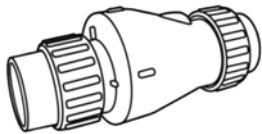

MCV823 Series



MCV850 Series

Part Number	Size	Description	Spring Tension	Ctn Qty
MCV821-10	1"	Slip x Slip	1/2 lb.	12
MCV821-10C	1"	Slip x Slip CLEAR	1/2 lb.	12
MCV821-15	1 1/2"	Slip x Slip	1/2 lb.	12
MCV821-15C	1 1/2"	Slip x Slip CLEAR	1/2 lb.	12
MCV821-20	2"	Slip x Slip	1/2 lb.	12
MCV821-20C	2"	Slip x Slip CLEAR	1/2 lb.	12
MCV821-20M	2"	Slip x Slip w/magnet	2 lb.	12
MCV821-20MC	2"	Slip x Slip w/magnet CLEAR	2 lb.	12
MCV823-10	1"	Union x Union	1/2 lb.	12
MCV823-10C	1"	Union x Union CLEAR	1/2 lb.	12
MCV823-15	1 1/2"	Union x Union	1/2 lb.	12
MCV823-15C	1 1/2"	Union x Union CLEAR	1/2 lb.	12
MCV823-20	2"	Union x Union	1/2 lb.	12
MCV823-20C	2"	Union x Union CLEAR	1/2 lb.	12
MCV823-20M	2"	Union x Union w/magnet	2 lb.	12
MCV823-20MC	2"	Union x Union w/magnet CLEAR	2 lb.	12
MCV850-15	1 1/2"	Check/Slice Combo Union x Slip		12
MCV850-20	2"	Check/Slice Combo Union x Slip		12

# Butterfly Valves - Ductile Iron



HBFV Series

## Ductile Iron Butterfly Valve Features:

- Designed for swimming pool, irrigation and water systems.
- Wafer body features 4 alignment holes.
- Lever lock handle (spring loaded) provides excellent manual control for balancing or shut off services.
- Notched throttling plate allows balancing in 10° increments in any position desired within 90° arc rotation of the disc.
- Positive bubble-tight shutoff with minimum torque.
- Seat face eliminates need for flange gaskets.
- Phenolic backed seats prevent collapse, are stretch resistant, blowout proof and field replaceable.
- **EPDM seats** temperature rated at -30°F to 275°F.
- 420 stainless steel shaft
- Bidirectional dead-end capability for 250 psi (2" - 12").
- Compatible with ANSI 125/150 flanges.
- Designed to comply with MSS SP-67 and API 609.
- **Ductile iron, ENP plated** disc.
- Third party certified no-lead.
- Imported



HBFV GEAR Series

Part No.	Size	Weight(lbs)	Ctn Qty
<b>Ductile Iron ENP Plated Disc</b>			
HBFV2	2"	7	1
HBFV2 1/2	2-1/2"	8	1
HBFV3	3"	10	1
HBFV4	4"	12	1
HBFV5	5"	15.5	1
HBFV6	6"	17.5	1
HBFV8	8"	33	1
HBFV10	10"	50	1
HBFV12	12"	74	1

## Ductile Iron ENP Plated Disc - GEAR DRIVE

HBFV6-GEAR	6"	28.5	1
HBFV8 GEAR	8"	54	1

Flanges & Bolt kits available, see page P.26

# Butterfly Valves - Ductile Iron

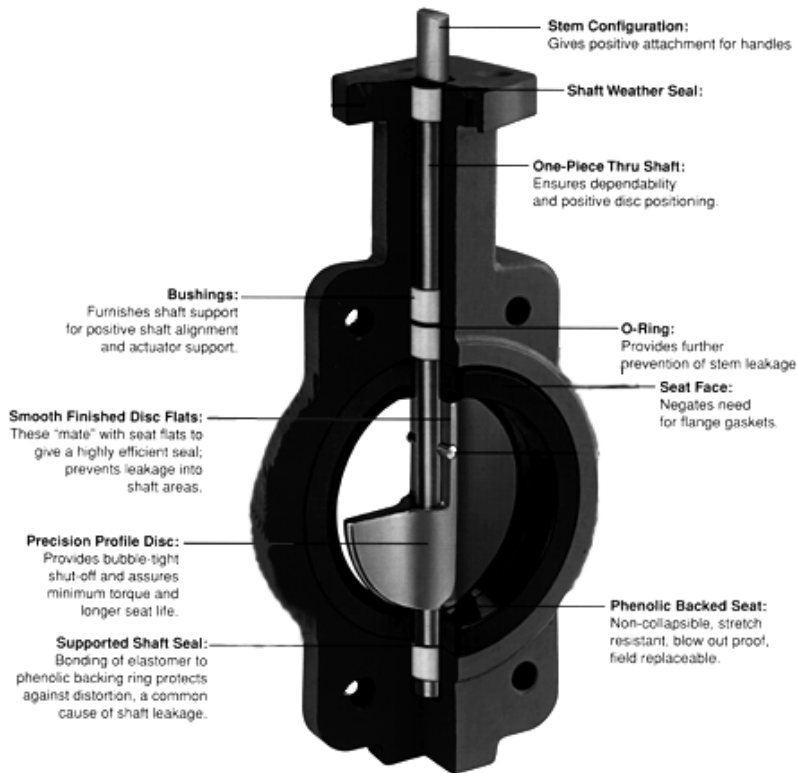

## MATERIAL SPECIFICATIONS

No.	Part	Material
1	Body	DUCTILE Iron
2	Disc	Ductile Iron
3	Seat	EPDM
4	Shaft	420 Stainless Steel
5	Key	Carbon Steel
6	O-ring	EPDM
7-9	Bushing	Nylon

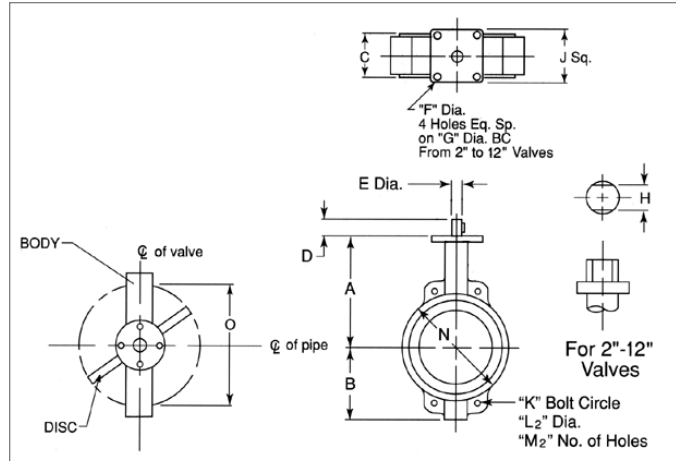
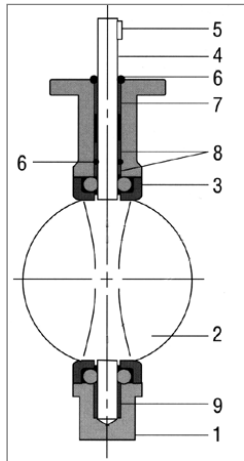

## SIZE \ DIMENSION (in) for HBFV Series

	A	B	C	D	E	F	G	H	J	K	L <sub>2</sub>	M <sub>2</sub>	N	O
2"	5.51	2.44	1.64	1.26	.50	.375	2.76	.39	2.75	4.75	.75	4	4.75	2.12
2 1/2"	6.02	2.76	1.75	1.26	.50	.375	2.76	.39	2.75	5.5	.75	4	5.50	2.57
3"	6.26	2.89	1.75	1.26	.50	.375	2.76	.39	2.75	6.0	.75	4	6.00	3.14
4"	7.01	4.49	2.00	1.26	.625	.375	2.76	.47	2.75	7.50	.75	4	7.50	4.13
5"	7.50	4.79	2.13	1.26	.75	.375	2.76	.55	2.75	8.50	.87	4	8.50	5.12
6"	8.01	5.55	2.12	1.26	.75	.375	2.76	.55	2.75	9.50	.87	4	9.50	6.13
8"	9.50	6.85	2.50	1.26	.875	.438	4.02	.67	3.75	11.75	.87	4	11.75	8.15
10"	10.75	8.19	2.50	1.58	1.125	.438	4.02	.87	3.75	14.25	1.00	4	14.29	9.98
12"	12.25	9.53	2.99	1.58	1.125	.438	4.02	.95	3.75	17.00	1.00	4	17.00	11.89



PBFV Series

ISO 9002



### MATERIAL SPECIFICATIONS

No.	Part	Material	Qty
1	Body	PVC	1
2	Disc	PP	1
3	Seat Seal	EPDM	1
4	Stem	SS 410	1
5	O-ring	EPDM	2
6	O-ring	EPDM	2
7	Inserted Nut	SS 41	3
8	Large Handle	ABS	1
9	Small Handle	ABS	1
10	Spring Lock	ABS	1
11	Handle Insert	SS	1
12	Handle Lever	SS 304	1
13	Spring	SS 304	1
14	Spring Pin	SS 304	1
15	Spring Pin	SS 304	1
16	Washer	SS 304	1
17	Locking Plate	SS 304	1
18	Gear Seat	PP + GF	1
19	Washer	SS 304	1
20	Bolt	SS 304	3
21	Nut	PVC	1
22	Insert Nut	C3604	1
23	Level	SS 304	1
24	Rivet	SS	2

**CV (GPM)/(1 lbf/in<sup>2</sup>)<sup>1/2</sup>**  
**Opening Rate: 90°**

SIZE	CV
2"	100.87
2 1/2"	137.82
3"	224.08
4"	409.51
5"	523.92
6"	1243.00

### PVC Sch 80 Butterfly Valves Features:

- 150 PSI working pressure.
- PVC body, polypropylene disc, and EPDM seat and o-ring.
- Flanged end design.
- Corrosion resistant.
- Excellent flow characteristics.
- Ideally suited for flow control in a minimum piping space.
- Clear indication of disc opening degree.
- Built in seat requires no additional gaskets between flanges.
- Manufactured for AGI in an ISO 9002 facility.
- Imported.

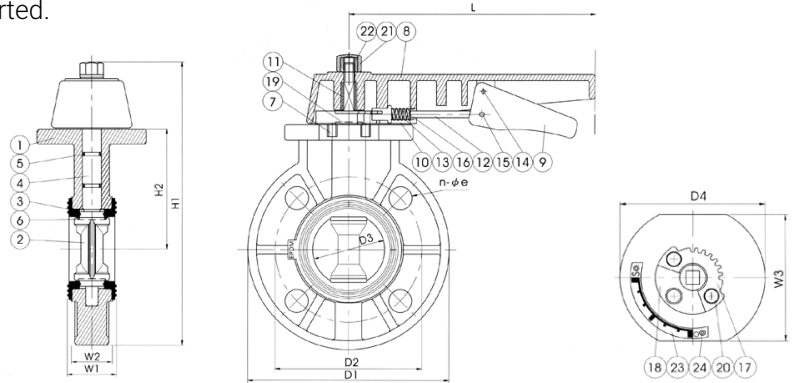

### DIMENSIONS \ SIZE (in)

	2"	2 1/2"	3"	4"	5"	6"	8"
D1	6.44	7.22	7.80	8.93	9.98	11.12	13.38
D2	4.70	5.44	5.94	7.43	8.42	9.42	11.64
D3	2.20	2.71	3.10	4.01	5.11	6.02	7.91
D4	4.13	4.66	4.84	5.26	6.40	6.64	7.84
L	7.92	7.92	7.92	9.91	11.86	11.86	11.86
H1	9.59	10.37	10.76	12.40	15.21	15.80	18.17
H2	4.02	4.41	4.49	5.27	5.85	6.90	8.19
W1	1.67	1.85	1.85	2.23	2.57	2.88	3.41
W2	1.35	1.45	1.45	1.83	2.22	2.53	3.06
W3	3.67	3.67	3.66	3.89	4.31	3.93	4.76
n-oe	.741	.741	.741	.741	.858	.858	.858

Part Number	Description	Ctn Qty
PBFV2	2" PVC Butterfly valve	4
PBFV21/2	2 1/2" PVC Butterfly valve	4
PBFV3	3" PVC Butterfly valve	4
PBFV4	4" PVC Butterfly valve	4
PBFV5	5" PVC Butterfly valve	4
PBFV6	6" PVC Butterfly valve	4
PBFV8	8" PVC Butterfly valve	1
<b>Replacement handles</b>		
PBFV2 HANDLE	2" PVC valve handle	1
PBFV21/2 HANDLE	2 1/2" PVC valve handle	1
PBFV3 HANDLE	3" PVC valve handle	1
PBFV4 HANDLE	4" PVC valve handle	1
PBFV5 HANDLE	5" PVC valve handle	1
PBFV6 HANDLE	6" PVC valve handle	1
PBFV8 HANDLE	8" PVC valve handle	1

# Flanges, Bolt Kits, Gaskets

## PVC Sch 80 Van Stone Flange Features:

- Two-piece van stone socket style.
- Class 150, Schedule 80
- Improve the security and safety of connections between pipes, valves & fittings.
- Imported - Manufactured for AGI in an ISO 9002 facility.



PF Series

ISO 9002



	DIMENSIONS \ SIZE (in)						
	2"	3"	4"	6"	8"	10"	12"
D1	5.93	7.49	8.93	11.08	13.38	15.83	18.76
D2	4.72	5.93	7.45	9.40	11.62	14.12	16.85
D3	2.96	4.21	5.19	7.45	9.28	12.09	14.20
d	1.99	3.00	3.98	6.08	7.96	9.98	11.97
d1	2.35	3.46	4.45	6.55	8.53	10.64	12.62
d2	2.37	3.48	4.48	6.59	8.57	10.68	12.67
H	1.68	2.11	2.50	3.32	4.60	5.85	7.45
T	.78	1.01	1.09	1.25	1.40	1.64	1.64
l	1.49	1.86	2.23	2.97	3.98	4.80	6.44
n-oe	.741	.741	.741	.858	.858	.936	.975

Part Number	Description	Ctn Qty
PF2	2" Flange	60
PF2 1/2	2 1/2" Flange	36
PF3	3" Flange	30
PF4	4" Flange	20
PF6	6" Flange	10
PF8	8" Flange	4
PF10	10" Flange	2
PF12	12" Flange	2

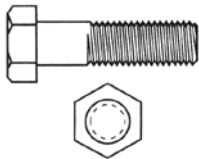
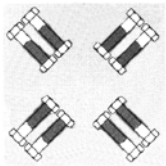

BBK Series

## Bolt Kit Features:

- For use with cast iron & PVC butterfly valves. BF8200, HBFV and PBFV Series
- ASTM-A307 grade zinc plated carbon steel bolts and A563 finished nuts.
- Washers and Gaskets NOT included- Available upon request.

Part Number	Valve Size	Bolt Size	Bolts/Kit	Ctn Qty
BBK2	2"	5/8" x 5"	4	16
BBK2.5/3	2 1/2" and 3"	5/8" x 5 1/2"	4	16
BBK4	4"	5/8" x 6"	8	8
BBK5/6	5" and 6"	3/4" x 6 1/2"	8	8
BBK8	8"	3/4" x 7"	8	8
BBK10	10"	7/8" x 7 1/2"	12	3
BBK12	12"	7/8" x 8 1/2"	12	3

## Red Rubber Gasket Features:

- For use with butterfly valves, Sch 80 flanges
- Red rubber, 150 lbs., 1/8" full face.



GSK Series

Part Number	Valve Size	Part Number	Valve Size
GSK11/2R	1 1/2"	GSK5R	5"
GSK2R	2"	GSK6R	6"
GSK2 1/2R	2 1/2"	GSK8R	8"
GSK3R	3"	GSK10R	10"
GSK4R	4"	GSK12R	12"

## Butterfly Valve Installation Kit Features:

- Everything needed for a quick, easy butterfly valve installation.
- Available with PVC Sch 80 or Ductile Iron butterfly valves.
- Custom kits available upon request.



PBVIK Series



## PVC Butterfly Valve Installation Kit Includes:

- One PBFV Series PVC Sch 80 Butterfly valve.
- Two PF Series PVC Sch 80 Van Stone flanges.
- Two red rubber GSK gaskets.
- Bolt kit with steel nuts and bolts.
- Steel washers.

Part Number	Size	Number of Nuts/Bolts	Number of Washers	Ctn Qty
PBVIK2	2" Kit	4	8	1
PBVIK2 1/2	2 1/2" Kit	4	8	1
PBVIK3	3" Kit	4	8	1
PBVIK4	4" Kit	8	16	1
PBVIK6	6" Kit	8	16	1
PBVIK8	8" Kit	8	16	1



PHBFV Series



## Ductile Iron Butterfly Valve Installation Kit Includes:

- One HBFV Series Ductile Iron Butterfly valve.
- Two PF Series PVC Sch 80 Van Stone flanges.
- Bolt kit with steel nuts and bolts.
- Steel washers.
- Rubber gaskets NOT included. (Extended EPDM seat on the HBFV valve acts as gasket seal with flange.)

Part Number	Size	Number of Nuts/Bolts	Number of Washers	Ctn Qty
PHBFV2NG	2" Kit	4	8	1
PHBFV3NG	3" Kit	4	8	1
PHBFV4NG	4" Kit	4	8	1
PHBFV6NG	6" Kit	4	8	1
PHBFV12NG	12" Kit	4	8	1*

\* Shipped in two cartons





## Clear Braided PVC Hose Standard Wall, Class 125 Features:



- Flexible, see through clear hose with braid pattern reinforcement of two polyester spirals.
- Flexible clear PVC NSF 51 certified to 100°F (38°C), USP CLASS V1 rated.
- All hose compound ingredients used are listed in US FDA CFR, Title 21.
- Temperature range + 25° to 150° F / -5° to +65°C.
- Silicone free.
- Food and beverage grade, standard wall.
- Use for air, water lines.

Part Number	Nominal (inches)		Max Working Pressure		Reel Length	Approx Wt per CFT.
	ID	OD	PSI@68°F	PSI@122°F		
CBH25-1	1/4	0.438	250	105	100'	5.7 lbs
CBH38-1	3/8	0.594	225	97	100'	9.0 lbs
CBH50-1	1/2	0.750	200	86	100'	13.8 lbs
CBH58-1	5/8	0.875	200	86	100'	16.5 lbs
CBH75-1	3/4	1.030	150	65	100'	21.9 lbs
CBH100-1	1	1.300	125	54	100'	31.5 lbs
CBH100-2	1	1.300	125	54	200'	31.5 lbs
CBH125-50	1 1/4	1.625	100	43	50'	45.0 lbs
CBH125-1	1 1/4	1.625	100	43	100'	45.0 lbs
CBH150-50	1 1/2	1.937	100	43	50'	64.0 lbs
CBH150-1	1 1/2	1.937	100	43	100'	64.0 lbs
CBH200-1	2	2.490	75	33	100'	95.0 lbs

**\*\* Temperatures higher than 68° F reduce available working pressure. See next page for temperature, working pressure calculation chart and cautionary note.**

## Effects of Elevated Temperatures on Thermoplastic Hose.

The compounds used in clear braided PVC hose are generally referred to as thermoplastics. These materials achieve their optimum physical properties at room temperature, 68°F (20°C). As these materials are exposed to increased ambient temperatures, they will soften and their physical properties will change. This will have the effect of sharply reducing the available working pressure. Coupling retention will also be reduced. The charts below illustrate this effect. In all cases, the product should be tested in a controlled, secure and safe environment, and all operating conditions should be considered prior to use.

**All published working pressures of AGI Series CBH hose are based on a room temperature of 68°F (20°C).**

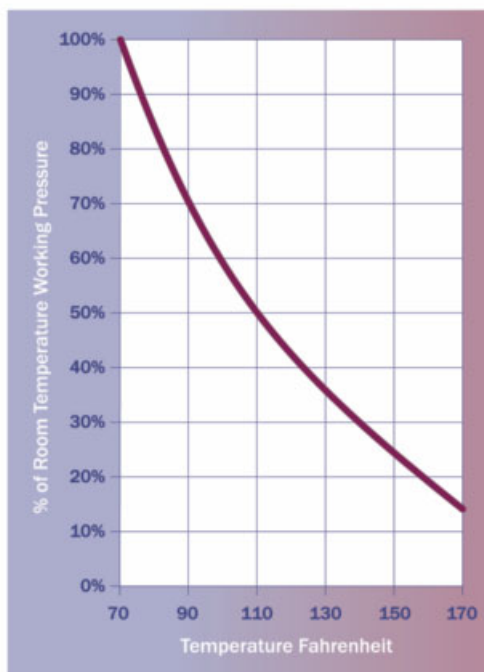

### Example from the Fahrenheit Chart

If working pressure at 68°F is 200 psi, then the WP at 110°F is 200 x 50%, or 100 psi

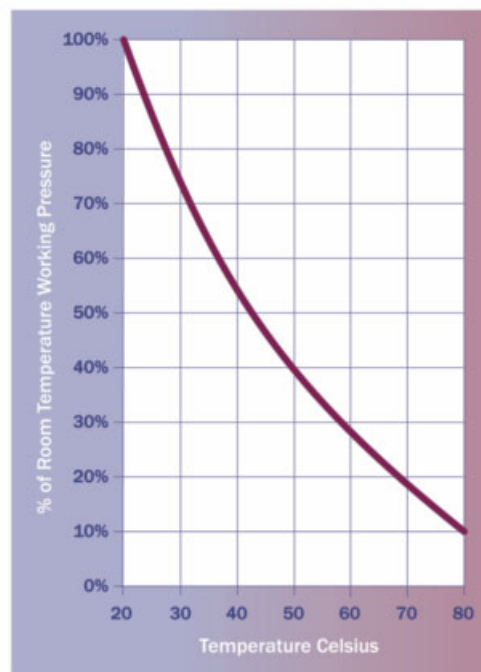

### Example from the Celsius Chart

If working pressure at 20° is 14 bar, then the WP at 50°C is 14 x 50%, or 5.6 bar

## CAUTIONARY NOTE

The charts are to be used as a guideline only. The information and recommendations contained here are, to the best of our manufacturer's knowledge, accurate and reliable, but no guarantee of their accuracy is made. All products are sold upon the condition that purchasers shall make their own tests to determine the suitability of such products for their particular purposes and uses, and purchasers assume all risks and liability for the results of use of the products, including use in accordance with seller's recommendations. Variability in length of exposure, temperature, pressure, velocity of fluid, and chemical concentration all contribute to reduced working pressure and hose reliability.

# Tubing - Polyethylene



## Polyethylene Tubing Features:

- Conforms to FDA, NSF and USDA Standards.
- Temperature Range -100° F to +140° F
- Economical.
- Extremely Flexible.
- Translucent.
- Resists Corrosion.
- **NOT FOR USE WITH HOT WATER**



- **SOLD IN COIL LENGTHS ONLY.**
- ORDER BY THE NUMBER COIL LENGTHS REQUIRED.  
Ex: For 500' of MV4040-5 order Qty 1 MV4040-5

Part Number Bulk Boxed	Part Number Dispenser Box	OD	ID	Wall Thickness	Max PSI @ 70°F	Coil Length
MV4040-1BLACK		1/4"	.17"	0.04"	135	100'
MV4040-1		1/4"	.17"	0.04"	135	100'
MV4040-5		1/4"	.17"	0.04"	135	500'
MV4040M		1/4"	.17"	0.04"	135	1000'
MV4062-1		1/4"	1/8"(.125)	1/16"(.062)	180	100'
MV4062-5		1/4"	1/8"(.125)	1/16"(.062)	180	500'
MV4062M		1/4"	1/8"(.125)	1/16"(.062)	180	1000'
MV5062-1		5/16"	3/16"(.1875)	1/16"(.062)	140	100'
MV5062-5		5/16"	3/16"(.1875)	1/16"(.062)	140	500'
MV5062M		5/16"	3/16"(.1875)	1/16"(.062)	140	1000'
MV6062-1		3/8"	1/4"(.250)	1/16"(.062)	120	100'
MV6062-5		3/8"	1/4"(.250)	1/16"(.062)	120	500'
MV6062-5BLACK		3/8"	1/4"(.250)	1/16"(.062)	120	500'
MV6062M		3/8"	1/4"(.250)	1/16"(.062)	120	1000'
MV8062-1		1/2"	3/8"(.375)	1/16"(.062)	90	100'
MV8062-5		1/2"	3/8"(.375)	1/16"(.062)	90	500'
MV10062-1		5/8"	1/2"(.500)	1/16"(.062)	70	100'
MV10062-5		5/8"	1/2"(.500)	1/16"(.062)	70	500'
MV12075-1		3/4"	.6	.075	60	100'
MV16093-1		1"	.814	3/32"(.094)	55	100'



TP309	5/16"	3/16"(.1875)	1/16"(.062)	100'
-------	-------	--------------	-------------	------

## POLYETHYLENE TUBING SIZING GUIDE

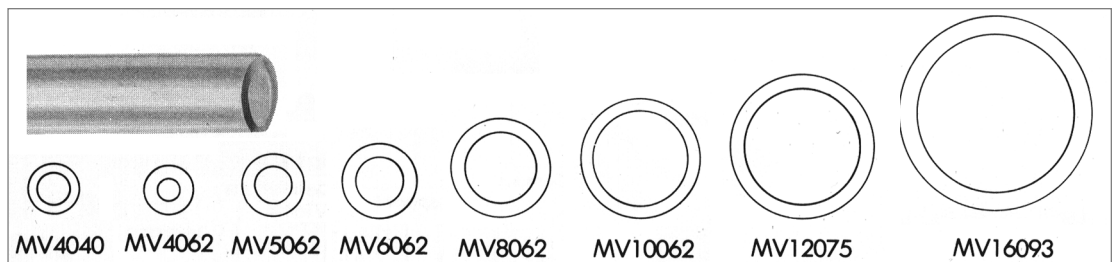

# Tubing - Clear Vinyl



### Vinyl Tubing Features:

- Temperature Range -20° F to +150° F
- Flexible.
- Transparent.
- Tasteless.
- Non-Toxic.
- **NOT FOR USE WITH HOT WATER**



### Applications:

- Pool slides
- RV use cold water
- Water softeners
- Ice maker
- Livestock
- Food & Beverage

• **SOLD IN COIL LENGTHS ONLY.**  
 • ORDER BY THE NUMBER COIL LENGTHS REQUIRED.  
 Ex: For 500' of IV7062-5 order Qty 1 IV7062-5

Part Number	Bulk Box	Dispenser Box	OD	ID	Wall Thickness	Length
IV4062-1			1/4"	1/8"(.125)	1/16"(.062)	100'
IV5062-1			5/16"	3/16"(.1875)	1/16"(.062)	100'
IV6062-1			3/8"	1/4"(.250)	1/16"(.062)	100'
IV7062-1			7/16"	5/16"(.3125)	1/16"(.062)	100'
IV8062-1			1/2"	3/8"(.375)	1/16"(.062)	100'
IV10062-1			5/8"	1/2"(.500)	1/16"(.062)	100'
		TV309	5/16"	3/16"(.1875)	1/16"(.062)	100'



### VINYL TUBING SIZING GUIDE

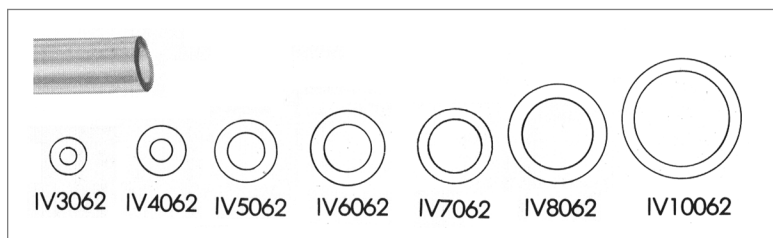



### Barb Fitting Features:

- Superior NO LEAD brass fittings for soft plastic tubing for oil, water, air, vacuum, gas and liquid low pressure lines.
- Exclusive self-clinching double barbs actually tighten under strain.

### Compression Fitting Features:

- NO LEAD Brass compression fittings designed for plastic tubing.
- Built-in tube support prevents tube collapse and allows easy assembly.



**VT22**

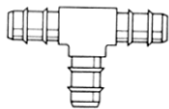

**VT224**

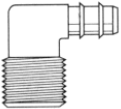

**VT229**

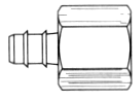

**VT26**

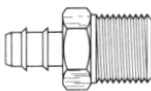

**VT28**

Part Number	Fits Tube OD	Fits Tube ID	Thread Size	Qty
<b>Coupling (Ins x Ins)</b>				
VT22-4-4NL	3/8"	1/4"		Bulk
VT22-6-6NL	1/2"	3/8"		Bulk
<b>Tee (Ins x Ins x Ins)</b>				
VT224-6NL	1/2"	3/8"		Bulk
<b>Elbow (Ins x MIP)</b>				
VT229-4-4NL	3/8"	1/4"	1/4" mip	Bulk
VT229-6-4NL	1/2"	3/8"	1/4" mip	Bulk
<b>Female Adapter (Ins x FIP)</b>				
VT26-6-4NL	1/2"	3/8"	1/4" fip	Bulk
<b>Male Adapter (Ins x MIP)</b>				
VT28-4-2NL	3/8"	1/4"	1/8" mip	Bulk
VT28-4-4NL	3/8"	1/4"	1/4" mip	Bulk
VT28-6-4NL	1/2"	3/8"	1/4" mip	Bulk

# Fittings for Plastic Tubing - NL Brass

**VT62**

Part Number	Fits Tube OD	Fits Tube ID	Thread Size	Qty
<b>Union w/ inserts (Comp x Comp)</b>				
VT62-4NL	1/4" x 1/4"	.17"		Bulk

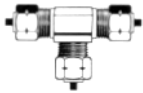
**VT64**

<b>Tee w/ inserts (Comp x Comp x Comp)</b>				
VT64-4NL	1/4" x 1/4" x 1/4"	.17"		Bulk

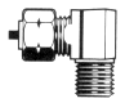
**VT69**

<b>Male Elbow w/ inserts (Com x MIP)</b>				
VT69-4-4NL	1/4"	.17"	1/4" mip	Bulk

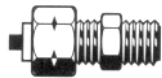
**VT68**

<b>Male Connector w/ inserts (Comp x MIP)</b>				
VT68-4-4NL	1/4"	.17"	1/4" mip	Bulk
VT68-6-4NL	3/8"	1/4"	1/4" mip	Bulk

**VT60**

<b>Delrin Sleeve</b>				
VT60-4	1/4"			Bulk
VT60-6	3/8"			Bulk

**VT61**

<b>Nut</b>				
VT61-4NL	1/4"			Bulk
VT61-5NL	5/16"			Bulk
VT61-6NL	3/8"			Bulk

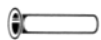
**VT63**

<b>Tube Support</b>				
VT63-4NL	1/4"	.17"		Bulk
VT63-6NL	3/8"	1/4"		Bulk



## 3M Spray Adhesives

### BLUE 72

- Repositionable BLUE pressure sensitive spray adhesive.
- One side bonds in 8 hours, aggressive tack, low soak in.
- Covers 100 sq ft.
- Ideal for pool liner installation.

### ORANGE FOAM FAST 74

- Permanent, light orange, fast tack.
- Two sides bond in 15 minutes.
- Covers 260 sq. ft.

Both manufactured for AGI in an ISO 900 facility.



ISO 9001

Part Number	Item	Size	Ctn/Pallet Qty
BLUE 72	Blue Spray Adhesive	24 fl oz can, 17.3 oz net wt.	12/768
ORANGE 74	Orange spray adhesive	24 fl oz can, 16.9 oz net wt	12/768



FAL32

## Fix A Leak Features:

Fix A Leak is a blended material, designed to seal leaks in just about anything. It works in any kind of pool, spa or hot tub, regardless of constructed material, concrete, fiberglass, acrylic, wood, etc. It works equally well in all plumbing materials including PVC, ABS, poly plastics, vulcathen, copper, steel, etc.

- Seals leaks up to 1/8" in diameter.
- Forms a permanent seal.
- One quart is designed to seal leaks in up to 20,000 gallons. Do not use in excess of 1 quart per 5,000 gallons of water.
- Cures in 24-48 hours.
- Patented by Marlig Industries, Inc.



**MARLIG INDUSTRIES, INC.**

Part Number	Description	Ctn Qty
FAL32	Fix A Leak Sealant, 32 oz.	12
FAL8	Fix A Leak Sealant, 8 oz.	20

See the "Tapes, Sealants, Cements" and "Permatex Industrial" tabs for more installation & repair materials.



2136



Swimming Pool,  
Fountain and Spa  
Equipment  
Conductor Splice  
Potting Compound  
2L02

### 3M Scotchcast™ 2136 Wet-Niche Potting Kit Features:

- Provides protection against corrosion and deteriorating effects of pool water by encapsulating the 8 AWG ground connection in a wet niche shell.
- The wet-niche shell is a corrosion-resistant metal housing for underwater fixtures in permanently installed pools.
- Product meets NEC requirements to allow the use of rigid nonmetallic conduit in the installation of wet-niche underwater lighting fixtures.
- Packaged in easy-mix, single use, 1.5 oz. container with cleaning pad, application stick and gloves.
- Will not sag or drip. Gels in minutes and can be submerged within 4 hrs.

Part Number	Description	Ctn Qty
2136	Wet-Niche Potting Kit	10



10-417-15

### Hot Water Swimming Pool Heater

#### Safety Relief Valve Features:

- Bronze safety relief valve protects ASME Section IV hot water heating boilers and hydronic heating systems.
- High capacity design features corrosion resistant construction.
- Ideal for use in swimming pool heater applications, hot water boilers and hydronic heating systems.
- ASME Section IV.
- Set pressure 75 psi. 20-80 psig certified pressure range.
- Maximum temperature service 250°F
- Stainless steel springs.
- Registered in all Canadian provinces and territories, CRN #0G8547.5C
- Made in USA.

Part Number	Description	Height	Ctn Qty
10-417-15	3/4" M/F Safety relief valve	3"	100

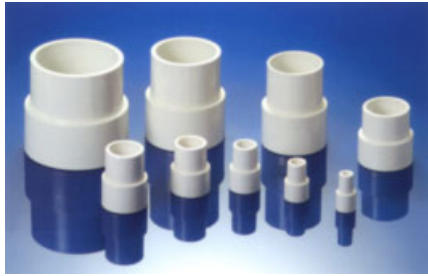

PEX Series



PIC Series

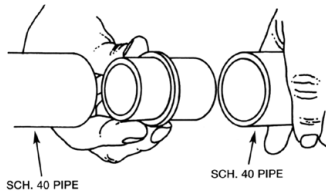
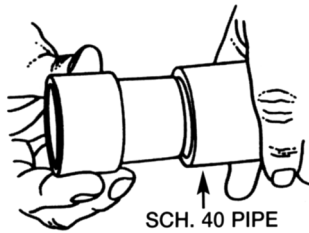

## Pipe Extender and Inside Connector Repair Fitting

### Features:

- For Sch 40 pipe.
- Saves labor.
- Invisible after installation.
- Permanent repair.
- Insignificant flow restriction.
- PVC Construction.
- PIC Series connects two pieces of Sch 40 pipe with flush joint.



Part Number	Description	IPS Size	Ctn Qty
<b>Pipe Extender Repair Fitting</b>			
PEX50	Pipe Extender	1/2"	48
PEX75	Pipe Extender	3/4"	48
PEX100	Pipe Extender	1"	48
PEX125	Pipe Extender	1 1/4"	48
PEX150	Pipe Extender	1 1/2"	48
PEX200	Pipe Extender	2"	48
PEX250	Pipe Extender	2 1/2"	96
PEX300	Pipe Extender	3"	96
PEX400	Pipe Extender	4"	48
<b>Inside Connector Repair Fitting</b>			
PIC100	Inside Connector	1"	48
PIC150	Inside Connector	1 1/2"	48
PIC200	Inside Connector	2"	48

**SPPW405**

### 2 in 1 Swimming Pool Plug Wrench Features:

- Fits 1 1/2" or 2" cleanout plugs.
- 31" long.
- Removable 18" plated steel handle.
- Heavy duty, powder coated steel to resist rust and corrosion.
- No welds to corrode.

Part Number	Description	Ctn Qty
SPPW405	1 1/2" / 2" pool plug wrench with handle	24
SPPW405H	Replacement handle only for SPPW405	250

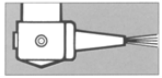
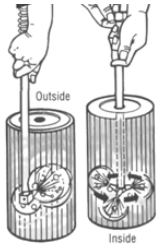
**MBC75**

### Master Blaster Cleaner Features:

- 3/4" FGHT connection.
- Handy on/off lever.
- For general pool/spa cleanup of filters, under copings.

Part Number	Description	Size	Ctn Qty
MBC75	Master Blaster Cleaner	3/4"	12

**AGLFB19**

### Ladder Bumper Features:

- White, molded EPDM.

Part Number	Description	Fits Tubes	Ctn Qty
AGLFB19	Male Ladder bumper	1.9" OD	200

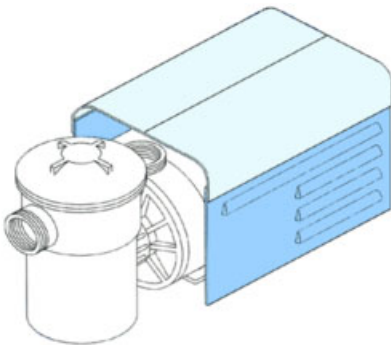
**B8200C**

### Universal Motor Cover Features:

- Fits all motors from 1/3 hp to 2 hp.
- Shields and protects outdoor motors from sun, rain and dust.
- Made of heavy duty plastic for long life and durability.
- Heat resistant white top and attractive blue sides.
- Sturdy, will not fade from sun or ultraviolet rays.
- Assembles in minutes. No tools needed.

Part Number	Description	Ctn Qty
B8200C	Universal Motor Cover	12



## Wingmaster® Plus Tool Features:

- The all in one **patented** tool for pool technicians.
- **Original** Wingmaster® Plus includes 7" cylinder, hexbar and hand knob.
- 5" Mini tool fits in tight spots such as main drains and skimmers.
- Nylon holster available separately.
- **US Patent #6,374,708**



MW, CWMP, RPNH

## Typical Applications



Tighten/loosen winterizing and pressure testing plugs



Remove plugs from pipe using threaded end tool or adapter



Install/remove slotted plugs



Install/remove flush plugs



Raise/lower safety cover anchors (1/4" and 3/16" hex)



Hold plugs in place for vacuuming

Part Number	Description	Ctn Qty
CWMP	Wingmaster Plus Tool 7"	1
MW	Mini Wingmaster Plus Tool 5"	1
RPNH	Nylon Holster for CWMP/MW	1



### Wingmaster® Anchor Extractor Features:

- Removes old cover anchors including anchors with escutcheons with the special design feature of the anchor extractor.
- **Anchor Extractor available only in NANSK or NANSK2 kit.**

#### To remove safety cover anchors:



1. Thread anchor with tap



2. Turn stud in anchor



3. Place extractor over stud



4. Thread castle nut onto extractor.



5. Attach tool. Turn clockwise to remove anchor.



6. Place square tip of stud into tool to remove old anchor from extractor.



Part Number	Description	Ctn Qty
JS	Hardened Stud (For 10-15 pulls)	1
CN	Castle Nut	1



**KEMB**

### KEMB - Wingmaster® Castle Nut Driver Features:

- Tightens and loosens Castle Nut (CN) with use of cordless screw gun.
- Used in the removal of safety cover anchors with the NANSK Kit.
- Works with 5/16 Tap for the tapping (threading) of cover anchors.

Part Number	Description	Ctn Qty
KEMB	Castle Nut Driver	1

### Wingmaster® Shell Extractor Kit Features:

- Removes brass anchor shells - pop-up or threaded style.
- Includes SEW wrench, 11/16 tap and shell adapter.
- Wrench and tap available separately.
- **Shell Adapter available only with NANSE kit.**



**NANSE**



1. Insert tap in pop-up shell to create threads (For threaded shell proceed to 2)



2. Thread adapter into shell



3. Thread stud in adapter 1/4"



4. Place tool on castle nut and turn clockwise to remove anchor

Part Number	Description	Ctn Qty
NANSE	Shell Extractor Kit	1
SEW	Shell Extractor Wrench	1
TAP1116	Tap 11/16	1

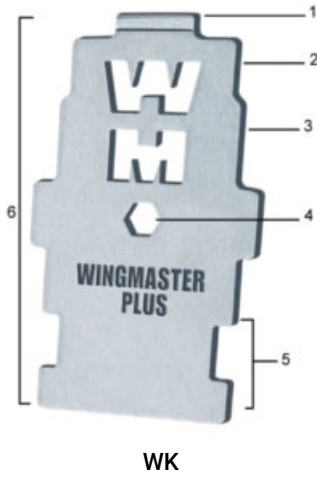

### Wingmaster® Key Features:

Multipurpose, stainless steel service tool.

1. Screwdriver.
2. Install/remove 3-way Hayward valve unions.
3. Install/remove directional fittings.
4. Use hex bar through center hole for more turning and torque.
5. Install/remove universal wall fittings.
6. Install/remove Waterway Poly Jet series face ring.



1. Screwdriver to raise/lower slot-  
ted anchors.



2. Install/remove  
3-way Hayward  
valve unions



3. Install/remove  
directional wall fit-  
tings

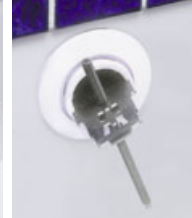

4-5. Install/remove  
universal wall fit-  
tings. Place hex bar  
in hole for more turn-  
ing and torque.

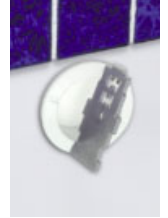

6. install /  
remove  
Waterway Poly  
Jet series face  
ring.

Part Number	Description	Ctn Qty
-------------	-------------	---------

WK	Wing Key	1
----	----------	---

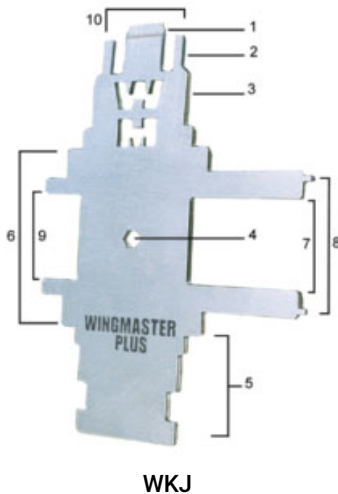

### Wingmaster® Jet Key Features:

Multipurpose, stainless steel service tool.

1. Screwdriver.
2. Install/remove 3-way Hayward valve unions.
3. Install/remove directional fittings.
4. Use hex bar through center hole for more turning and torque.
5. Install/remove Polaris/Letro universal wall fittings.
6. Install/remove Waterway Poly Jet face rings.
- 7-8. Install/remove Hayward jet nozzle retaining rings or broken ring tips.
9. Install/remove Hydro-Air spa jet face ring.
10. Install/remove Hydro-Air (Slim-line) face ring.



7. Install/remove  
Hayward jet nozzle  
retaining ring.

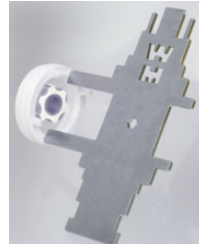

8. Install/remove broken  
Hayward retaining ring  
tips.



9. Install/remove  
Hydro-Air spa jet  
face ring



10. Install/remove  
Hydro-Air Slimline  
face ring.

Part Number	Description	Ctn Qty
-------------	-------------	---------

WKJ	Jet Key	1
-----	---------	---

Wingmaster® is an American Granby Inc. registered trademark.



**NANSK**



### Wingmaster® Plus Service Kit Features:

7" Multipurpose Wingmaster Plus tool, Anchor Extractor, Wing Key and carrying case.

#### Includes:

- Hand knob, cylinder, hex bar
- Anchor extractor, castle nut, hardened stud
- Anchor extractor for anchors with escutcheons (NANSK2 only).
- Wing key
- 12/24 tap
- 5/16 tap
- Molded Carrying case
- Wingmaster® Plus Tool. **US Patent # 6,374,708**

Part Number	Description	Ctn Qty
NANSK	Wingmaster Plus Service Kit	1
NANSK2*	Wingmaster Plus Service Kit	1
MHK	Hand Knob	1
MHB	Hex Bar	1
JS	Hardened Stud (For 10-15 pulls)	1
CN	Castle Nut	1
TAP1224	Tap 12-24	1
TAP516	Tap 5-16	1
BMC	Blow Molded Case	1

\* Includes anchor extractor for removal of anchors with escutcheons.



**KAAK**



**CTW**

**RSW**

**XPLUG**

**MW**

**SQW**

**SPW**

### Wingmaster® Plus Multipurpose Accessory Kit

#### Features:

Wrenches for multiple applications, packed in molded and padded case.

#### Includes:

- Caretaker Wrench
- Recessed Square Plug Wrench
- "X" Plug Wrench (JoSam)
- Square Plug Wrench
- Slotted Wrench for 1022 raised bar plug
- Mini Wingmaster® Plus Tool. **US Patent # 6,374,708**

Part Number	Description	Ctn Qty
KAAK	Multipurpose Accessory Kit	1
CTW	Caretaker Wrench	1
XPLUG	X Plug (JoSam)	1
SQW	Square Plug Wrench	1
SPW	Slotted Plug Wrench	1
MW	Mini Wingmaster Tool 5"	1



WB

### Wingmaster® Bar Features:

- Raise or lower cover anchors from a standing position.
- Fits 1/4" and 3/16" anchors.
- Overall bar length is 32".

Part Number	Description	Ctn Qty
WB	Bar	1



OTWAB

### Wingmaster® Wing Bit Features:

- Countersinks wood anchor flush to deck.
- Simple, fast and flush every time.
- Comes with 1 1/2" blade.
- 2" blade (Meyco) available.
- **US Patent # 7,264,427**

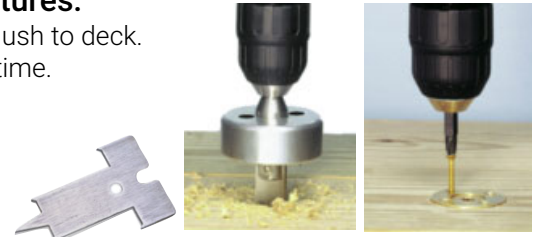

Part Number	Description	Ctn Qty
OTWAB	Wing Bit w/ 1 1/2" blade	1
OTRB1.5	Replacement Blade 1 1/2"	1
OTRB2	Replacement Blade 2"	1



HRVS

### Wingmaster® Hydrostatic Tool Features:

- Install or remove hydrostatic relief valves in main drain or Sylvan "X" plug (JoSam) and floor return cap.



Remove/install Hayward hydrostatic relief valve in main drain



Install/remove Sylvan floor return cap and "X" plug (JoSam)



Part Number	Description	Ctn Qty
HRVS	Hydrostatic Tool	1

Wingmaster® is an American Granby Inc. registered trademark.



SCRT

### Wingmaster® Easy Lift™ Spring Cover Removal Tool Features:

- Quick and easy installation and removal of cover springs with T-handle and quick spring grip.
- Stainless Steel T handle allows for greater leverage.
- Includes 1/4" and 3/16" stainless steel Allen wrenches to raise/lower anchors.
- 33" long steel bar.

Part Number	Description	Ctn Qty
SCRT	Spring Cover Removal Tool	1



LAW

### Wingmaster® Anchor Socket Washer Features:

- Contoured washer to fit handrail and ladder anchor sockets.
- Fits up to 3/8" bolt.
- Insures a tight fit for safety.
- Allows bolt to have flush fit and wider coverage around anchor socket.
- Completes pool bonding.

Part Number	Description	Ctn Qty
LAW25	Anchor Socket Washers, 25 pack	1



WMSK

### Wingmaster® Stencil Kit Includes:

- High quality stencils made of stainless steel.
- Numbers: 0,1,2,3,4,5,6,7,8,9, 1/2
- Letters for FEET, INCH, DEEP.
- NO DIVING symbol and words
- 2" high letters for FEET DEEP, INCHES DEEP.
- 3 top over spray panels.
- Molded storage case included.

Part Number	Description	Ctn Qty
WMSK4	Wing Stencil Kit, 4" high	1



PDT

### Wingmaster® Pipe Deburr Features:

- Removes PVC burrs from inside and outside of all size pipe.
- Cleans out pump impellers.
- Replacement blades available.



Part Number	Description	Ctn Qty
PDT	Pipe Deburr Tool	1
PDRB	Pipe Deburr Replacement Blade	1



MH

### Wingmaster® Multi-Handle Features:

- Attaches to many pool maintenance tools to shorten poles for easier use in spas and tight spaces.
- Two holes to accept delcron spring clips.
- Plastic handle cover for sure grip.
- Use with skimmer nets, wall brushes and pumice stones.
- Use with 4" and 8" algae brushes for cleaning heat exchangers.

Part Number	Description	Ctn Qty
MH	Multi Handle	1



BC

### Wingmaster® Burner Cleaner Features:

- Blow-through tube for hookup to compressed air.
- Textured (knurled) and curved end to grab spider webs.
- Easy access to accumulated debris in heater orifices.
- Works on Pentair, Zodiac and Hayward heaters.

Part Number	Description	Ctn Qty
BC	Burner Cleaner	1



DSSB

### Wingmaster® Drain Screw Security Bit Features:

- Tighten and loosen uni-screw for drain safe lids.

Part Number	Description	Ctn Qty
DSSB	Drain Screw Security Bit	1



# Winterizing Plugs



HWP Flush Plug



HWP Raised Plug



HWP Rubber Plug



## Winterizing Plug Applications:

- Safely seals swimming pool inlets and outlets against freezing.
- Temporary pluggings of any water system application for either pipe or fitting sizes.

## Plastic 1-1/2" Threaded Plug Features:

- Heavy duty, white ABS construction.
- EPDM o-ring is resistant to extreme weather & chemical corrosion.
- Gives a positive seal—no leaking.
- Available in raised or flush style.

## Rubber Expansion Plug Features:

- Stainless steel screw and washers.
- Nylon wing nut provides easier turning in cold temperatures, providing greater tightness than conventional plugs.
- Tapered.

Part Number	D (in)	Plug Size	Used For	Case/Ctn Qty
-------------	--------	-----------	----------	--------------

### Plastic

HWP1022B(Flush)	1-1/2"	White	1 1/2" fip	1000/50
HWP1022C(Raised)	1-1/2"	White	1 1/2" fip	1000/50

### Rubber

HWP2000	0.46	000	3/8" pipe	500/50
HWP200	0.63	0	1/2" pipe	500/50
HWP201	0.70	1	1/2" pipe	500/50
HWP202	0.75	2	3/4" tube	500/50
HWP203	0.89	3	3/4" pipe	500/50
HWP204	0.96	4	3/4" & 1" pipe	500/50
HWP205	1.02	5	1" tube	500/50
HWP2055	1.06	5 1/2	1" pipe	500/50
HWP206	1.20	6	1" fitting	500/50
HWP2065	1.27	6 1/2	1 1/4" pipe	200/20
HWP207	1.39	7	1 1/4" pipe	200/20
HWP2075	1.46	7 1/2	1 1/2" pipe	200/20
HWP208	1.54	8	1 1/2" pipe	200/20
HWP2085	1.62	8 1/2	1 1/2" pipe	200/20
HWP209	1.69	9	1 1/2" pipe & 1 1/4" ftg	200/20
HWP2095	1.73	9 1/2	1 1/2" fitting	200/20
HWP20975	1.81	9 3/4	1 1/2" fitting (for SP1023G)	200/20
HWP210	1.89	10	1 1/2" fitting	60/10
HWP211	2.13	11	2" pipe	60/10
HWP212	2.42	12	2" fitting	60/10
HWP213	2.58	13	2 1/2" pipe	30/5
HWP2135	2.82	13 1/2	3" pipe	40/5
HWP214	3.40	14	3" pipe	30/5
HWP215	3.86	15	4" pipe	30/5
HWP216	4.64	16	4" pipe	20/4
HWP1-5	1.02	01-05	Universal tapered 01-05	250/50
HWP5-7	1.36	05-07	Universal tapered 05-07	100/20
HWP7-10	1.78	07-10	Universal tapered 07-10	100/20

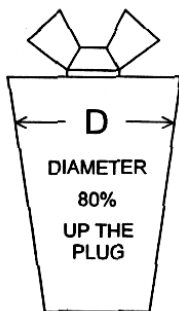
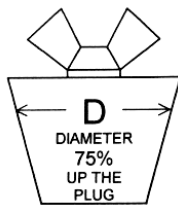

# Winterizing Plugs

## Extended Plug Features:

- Non-corrosive construction of heavy duty nylon wingnuts, stainless steel washers, spacers and high quality rubber.

## Double Plug Features:

- Non-corrosive construction of heavy duty nylon wingnuts, stainless steel washers, spacers and high quality rubber with brass stem.

## Blow Through Plug Features:

- Non-corrosive construction of heavy duty nylon wingnuts and caps, stainless steel washers, high quality rubber, extended brass air valve w/ spring loaded core.



HWP Extended Shaft



HWP Double Plug



HWP Blow Through



HWP Blow Through  
Universal Tapered

Part Number	Plug Size	Case/Ctn Qty
<b>Rubber Extended Shaft Plugs</b>		
HWP202X	2	250/50
HWP203X	3	250/50
HWP204X	4	250/50
HWP205X	5	250/50
HWP206X	6	250/50
HWP207X	7	200/20
HWP208X	8	200/20
HWP209X	9	200/20
HWP210X	10	60/10

Double Plugs	top x bottom x spacing length x top spacer	
HWP98DP35	Anthony "L3" 09 x 08 x 3.5" x 2.3"	40/10

<b>Blow-through Plugs</b>		
HWP202BT	2	500/50
HWP203BT	3	500/50
HWP204BT	4	500/50
HWP205BT	5	500/50
HWP206BT	6	200/50
HWP207BT	7	200/20
HWP208BT	8	200/20
HWP209BT	9	200/20
HWP2095BT	9 1/2	60/10
HWP210BT	10	60/10
HWP211BT	11	60/10
HWP212BT	12	60/10

HWP1-5BT	Universal Tapered 01 - 05	250/50
HWP5-7BT	Universal Tapered 05 - 07	100/20
HWP7-10BT	Universal Tapered 07 - 10	100/20



SKG Series

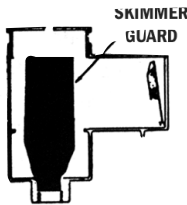

DCWT Series



AP44

## Winterizing accessories for pool closings



### SKG Skimmer Guard Features:

- Installs in skimmer to prevent freezing and breakage.
- Ends are threaded for 1 1/2" and 2" applications.
- SKG-H with blowout hole, o-ring seals to allow skimmer lines to be blown out without dropping water level.
- SKG9H fits SP1090 series skimmers.
- SKG16H fits SP1070 and SP1080 series skimmers.

### Water Tube and Air Pillow Features:

- Single and double tubes available.
- Double chambers extend life of water tubes.
- 12 and 20 mil thickness on tubes. 12 mil on pillows.
- Used for weighing down winter covers on inground pools.

Part Number	Description	Color	Ctn Qty
<b>Skimmer Guards</b>			
SKG9	9" Skimmer guard	Teal-Green	36
SKG9H	9" Skimmer guard w/ blowout hole	Teal-Green	36
SKG16	16" Skimmer guard	Teal-Green	24
SKG16H	16" Skimmer guard w/ blowout hole	Teal-Green	24
<b>Water Tubes</b>			
SCWT8	8' Single chamber, 12 mil	Blue	36
SCWT8-20	8' Single chamber, 20 mil	Blue	24
SCWT10	10' Single chamber, 12 mil	Blue	30
DCWT8	8' Double chamber, 12 mil	Blue	36
DCWT10	10' Double chamber, 12 mil	Blue	30
DCWT8-20	8' Double chamber, 20 mil	Blue	24
DCWT10-20	10' Double chamber, 20 mil	Blue	24
<b>Air Pillows</b>			
AP44	4' x 5' Air pillow, 12 mil	Blue	24
AP48	4' x 8' Air pillow, 12 mil	Blue	12

# Pool Cover & Utility Pumps



CCP300

### Pool Cover Pump Features:

- Magnetic drive motor - Only one moving part.
- Completely submersible.
- Easily hooks up to any standard 3/4" garden hose.
- Extra-long 25' power cord with grounded plug.
- Sturdy ceramic shaft impeller.
- Includes easy clean clog resistant foam filter.
- 1 year warranty.
- Listed to UL and cUL standards.



CCP350 / CCP500

Part Number	Description	Max Output	Max Pump Height	Ctn Qty
CCP300	Pool Cover Pump	300 gph	6'	18
CCP350	Pool Cover Pump	350 gph	7'	6
CCP500	Pool Cover Pump	500 gph	10.5'	6



91025 & 91330

### Submersible Utility Pump Features:

- 1/5 & 1/3 HP motors, 120 v, 60 Hz
- Corrosion resistant construction.
- 10' waterproof power cord.
- Clog resistant open type impeller.
- Fits in 6" opening.
- Capacities of 26 & 40 gpm.
- 3 year limited warranty.



### Specifications:

**Discharge:** 1 1/4" MNPT or 3/4" GHT  
**Housing & Base:** Thermoplastic  
**Impeller:** Thermoplastic  
**Bearing:** Permanently lubricating  
**Motors:** Permanent split capacitor, continuous duty, thermally protected



92250 & 92330

### Submersible Sump Pump Features:

- 1/4 & 1/3 HP motors, 120 v, 60 Hz
- Corrosion resistant construction.
- 10' waterproof power cord.
- Clog resistant open type impeller.
- Switch turns on at 9", off at 4".
- Handles 1/8" solids.
- 3 year limited warranty.



### Specifications:

**Discharge:** 1 1/4" MNPT  
**Housing & Base:** Thermoplastic  
**Impeller:** Thermoplastic  
**Bearing:** Permanently lubricating  
**Motors:** Permanent split capacitor, continuous duty, thermally protected

Model No.	HP	Gallons per minute at discharge height in feet						Min. Lift	Min. Amps
		0'	5'	10'	15'	20'	25'		
SP91025	1/5	26	21	14	10	7	1	25'	3.6
SP91330	1/3	40	34	28	22	12	2	25'	4.1
SP92250	1/4	30	22	20	16	9	2	25'	3.8
SP92330	1/3	40	34	28	22	12	2	25'	4.1

NOTE: Use of smaller diameter pipe, or long runs of pipe, will result in lower flow rates than those shown.